



Meccanizzazione agricola

Innovazioni tecnologiche

Aggiornamento

Davide Gnesini
Responsabile Servizio Tecnico
FederUnacoma

Webinar, 12 giugno 2023

Contenuti

FederUnacoma – chi siamo

Trattrici

Protezione colture – aspetti ambientali

Macchine per lavorazioni in pendenza

Macchine per irrigazione



FEDERUNACOMA

- Nata come associazione nel 1945, evoluta in federazione nel 2012
- Composta da sette associazioni: ASSOTRATTORI, ASSOMAO, ASSOMASE, COMAGARDEN, COMACOMP, ASSOIDROTECH, AGRIDIGITAL
- Aderisce a Confindustria --- CEMA, EGMF, FEM --- Agrievolution
- Sede centrale: Roma. Uffici: Bologna, Bruxelles
- Cura la realizzazione di EIMA International, Agrilevante, Agrimach (INDIA) ed altri eventi in collaborazione
- Oltre 300 aziende associate
- 80% dei siti produttivi italiani del settore
- 75% della produzione esportata
- Fatturato complessivo di circa 14 miliardi di euro



LA CERTIFICAZIONE

- Legislazione applicabile ai prodotti: trattori escluse, vale autocertificazione
- certificazione VOLONTARIA di terza parte → possibile valore aggiunto



- Regioni (PSR) → possono valorizzare certificazione
 - **Se** disponibile
 - Con **piccolo** vantaggio di punteggio
 - La certificazione **volontaria** deve restare tale, non diventare un obbligo di fatto



Trattrice - Motore

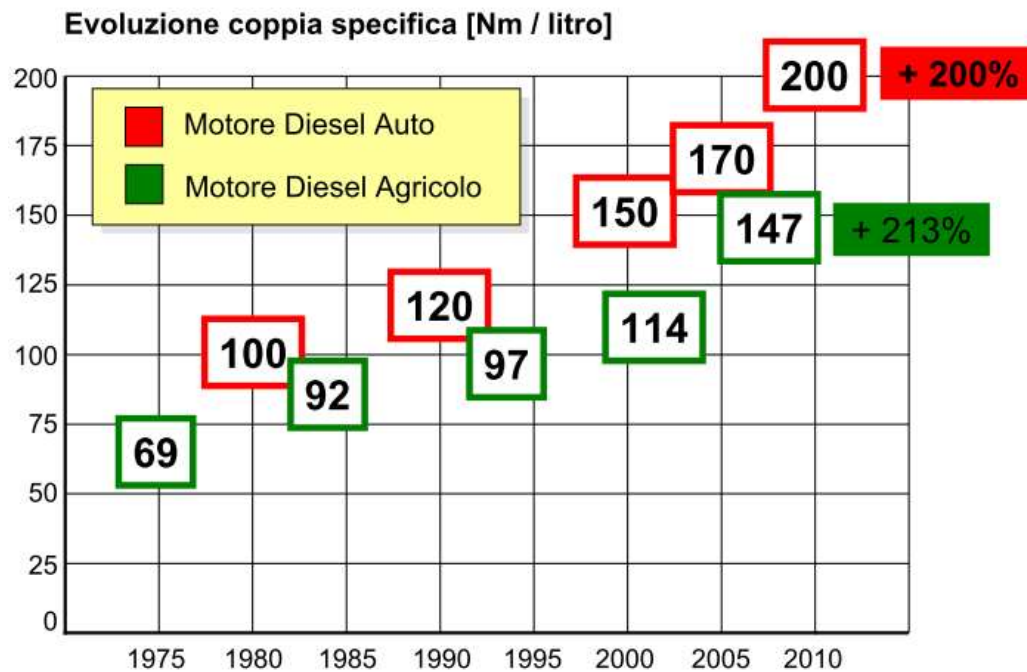



Evoluzione consumo specifico [g / CVh]

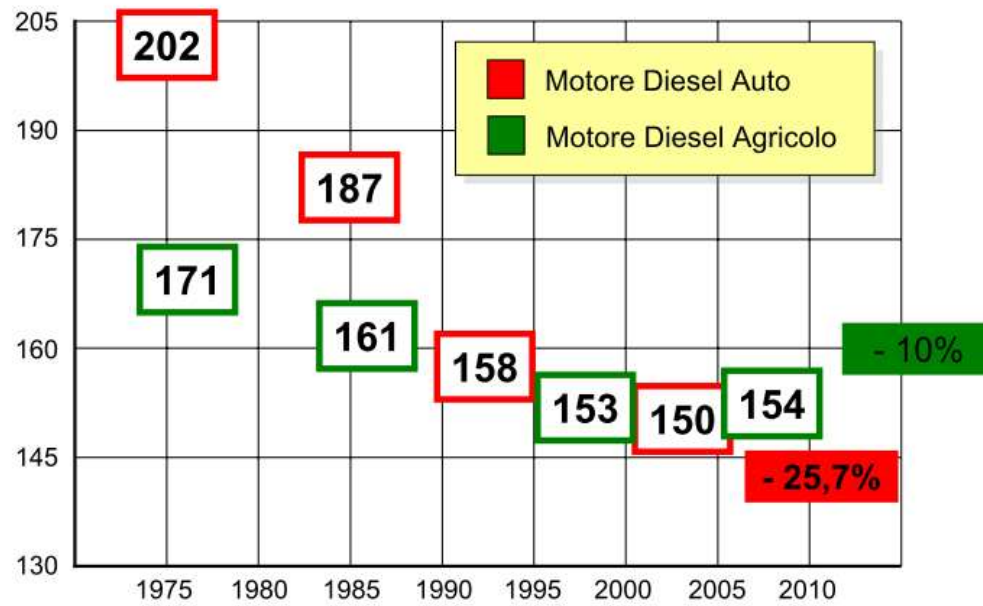



- Dagli anni '90, normative per limitare le emissioni dei motori diesel non stradali. «Stage» in EU, «TIER» in USA
- Secondo la potenza del motore, ciascuna normativa impone dei limiti sugli inquinanti: CO, HC, NOx, particolato
- Dal 2019 si applica la normativa Stage V (Reg. EU 1628/2016): limite sul PM del 40% inferiore allo Stage IV e nuovo limite sul numero di particelle PN. Conseguenza: DPF anche per 19-56kW
- Legislazione USA storicamente presa come riferimento. Con lo Stage V, EU è diventata la più restrittiva



Le emissioni di CO sono state ridotte del 30%, quelle di HC dell'80%

NOx e PM ridotte del 95%

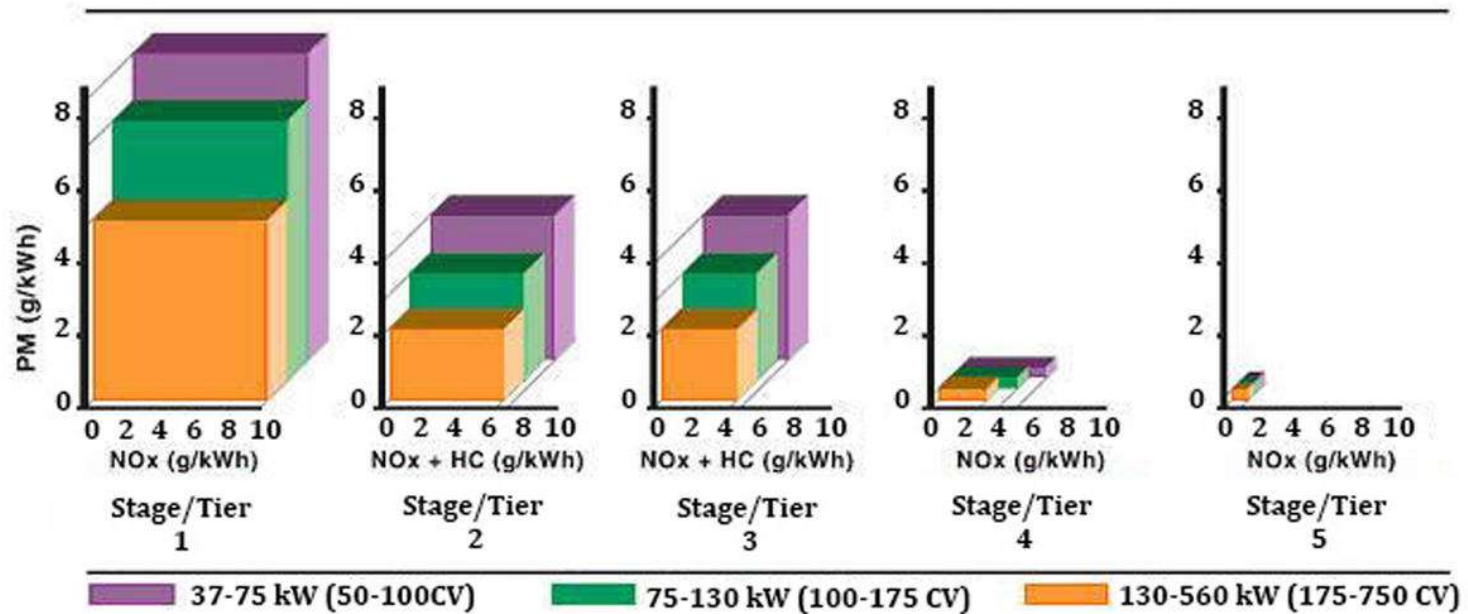

SCR

- Selective Catalytic Reduction: introdotto dai costruttori di trattatrici per la normativa Stage IV
- Trattamento dei gas di scarico con soluzione a base di urea -- si ottiene una miscela di acqua e azoto

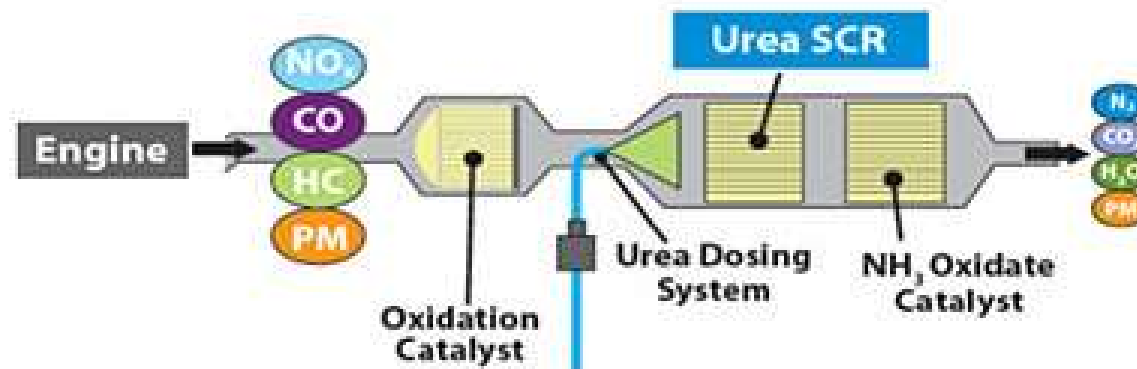



DPF

- Diesel Particulate Filter: introdotto per la normativa Stage III-B o V, a seconda delle fasce di potenza
- È un filtro in ceramica per le particelle solide del gas di scarico
- Dopo un certo numero di ore deve essere ripulito (rigenerazione)

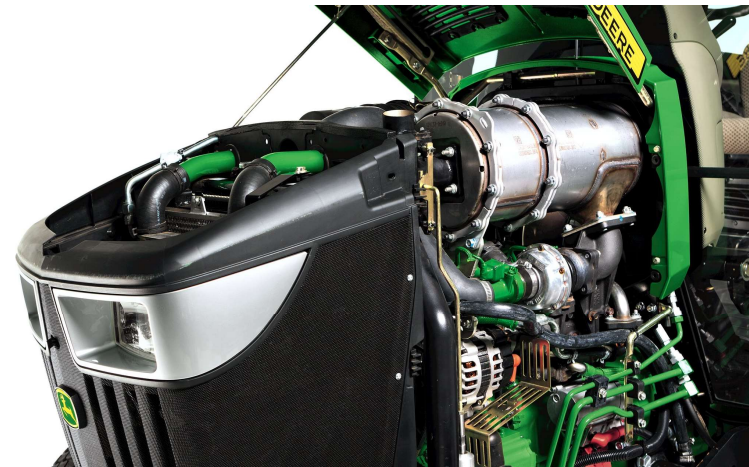
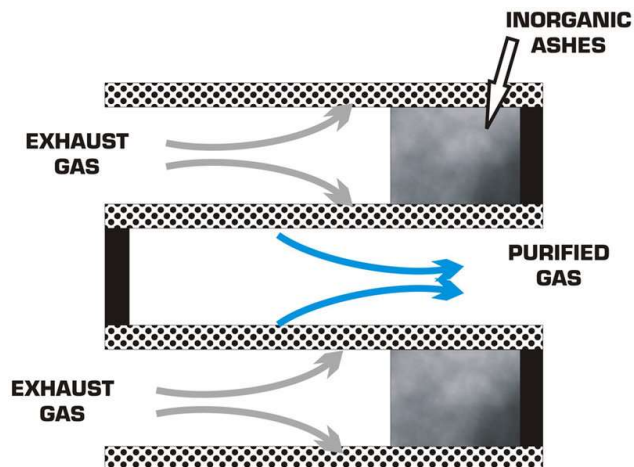





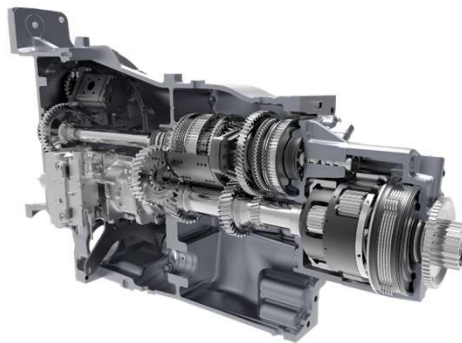

Trasmissione

- Necessità di combinare il punto di funzionamento ottimale del motore con le condizioni di lavoro
- Non sempre possibile con trasmissioni a rapporti finiti
- Necessità di poter cambiare marcia anche sotto carico per adeguare il motore alle condizioni locali del terreno



- 
- Le trasmissioni si sono evolute verso:
 - incremento del numero di rapporti
 - riduzione dei tempi di cambiata
 - Soluzioni tecnologiche:
 - Full Power Shift (FPS)
 - Continuously Variable Transmission (CVT)
 - Dual Clutch Transmission (DCT)
- 

Full Power Shift

Trasmissioni meccaniche con frizioni elettro-idrauliche in sostituzione dei classici innesti con sincronizzatori

Vantaggi: Rapidità e fluidità di cambiata – possibilità di variare rapporto, gamma e direzione sotto carico

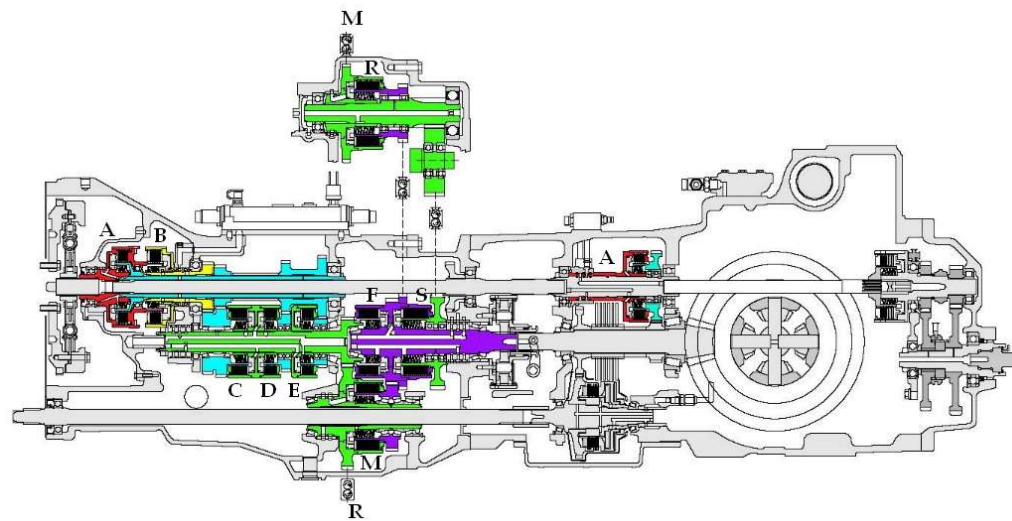



CVT

- Trasmissione mista con una componente meccanica ed una idrostatica unite da un rotismo epicicloidale
- Il rapporto di trasmissione può essere variato con continuità

Permette:

- velocità costante a carichi variabili, oppure
- numero di giri motore costante e variazioni automatiche velocità, a pieno carico
- «active neutral»

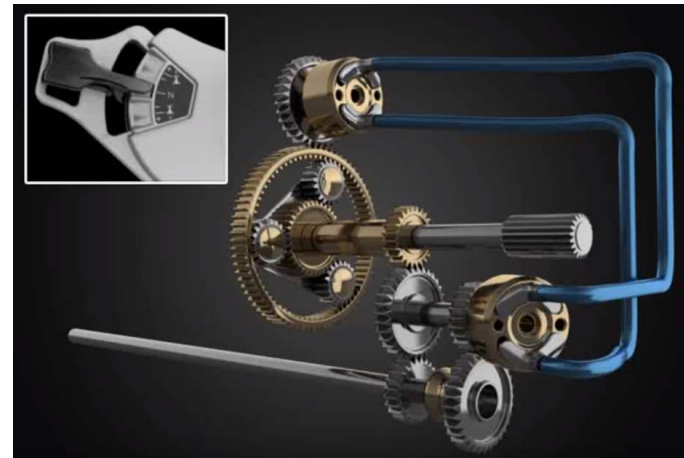

Dual Clutch Transmission

- Due alberi secondari: sul primo, ruote dentate delle marce pari. Sull'altro, marce dispari
- Quando è inserita una marcia la corrispondente frizione è chiusa; nell'altro albero viene preinserita una delle due marce adiacenti
- Per effettuare il cambio marcia viene staccata la prima frizione e innestata la seconda

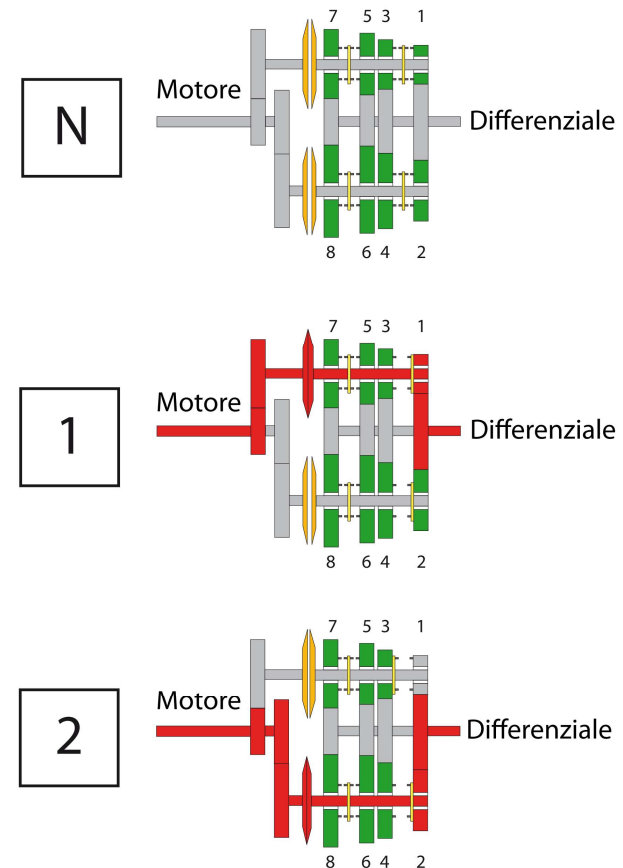



Cabina

Visibilità - Ergonomia



Filtrazione



Impianto di filtrazione a carboni attivi

Necessaria leggera pressurizzazione

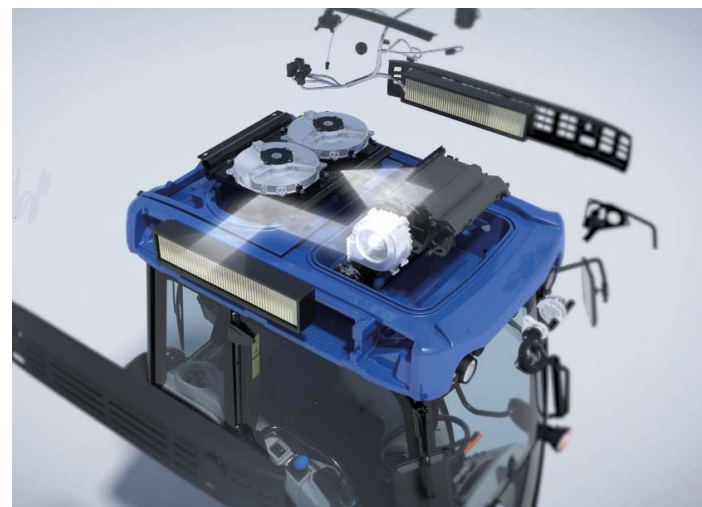



Sistemi sospensivi

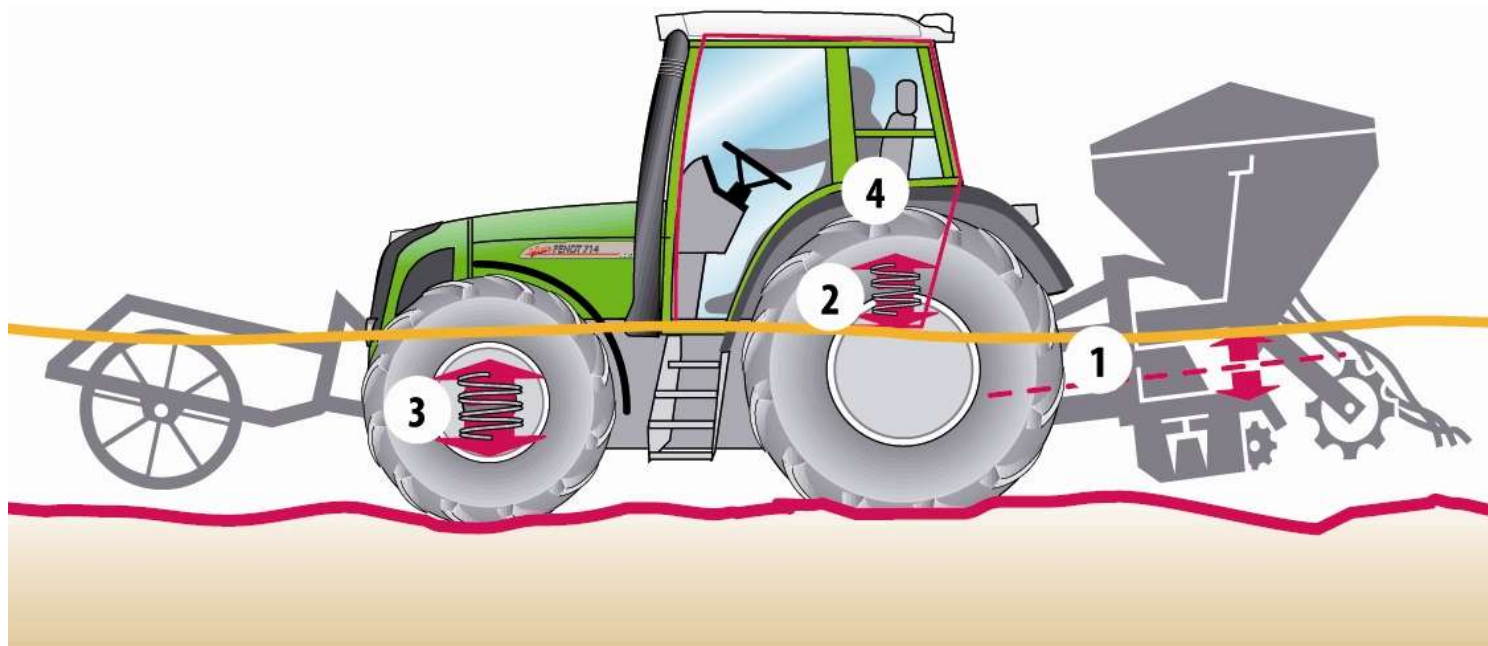

- 1 – sorgente di oscillazione
- 2 – sospensione cabina
- 3 – sospensione assale
- 4 – sospensione sedile



Sospensione cabina

- Costituita da elementi idro-pneumatici capaci di variare lo smorzamento
- Possibilità di regolazione predittiva dei parametri della sospensione in funzione delle condizioni operative

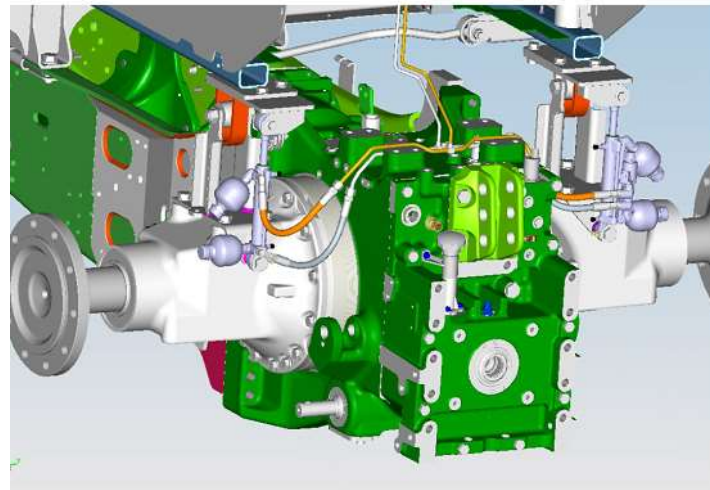

Sospensione assale

Sospensione idropneumatica

Un accelerometro permette la regolazione automatica dello smorzamento in estensione e in compressione



Sospensione sedile

Sospensione sedile con dispositivi attivi (smorzamento controllato e rigidità controllata)

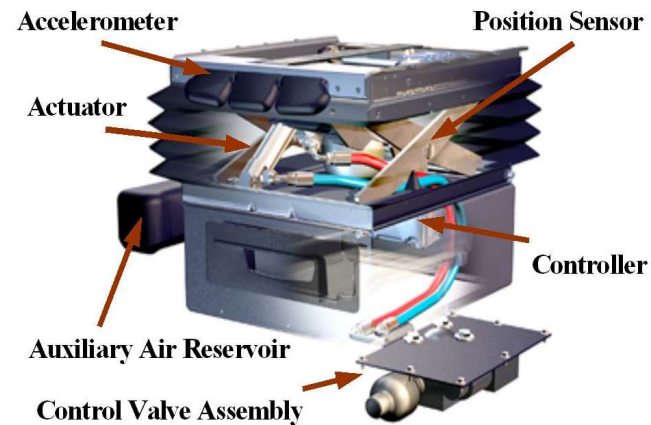

ABS

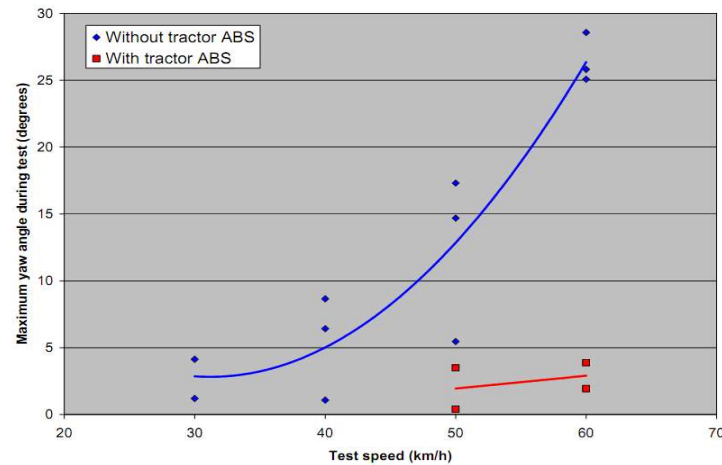

ABS facoltativo se V_{max} superiore ai 40 km/h ed obbligatorio per V_{max} uguale o superiore a 60 km/h

Organi di trazione

- Trattori sempre più potenti (e pesanti)
- Pressioni sempre più elevate sul terreno

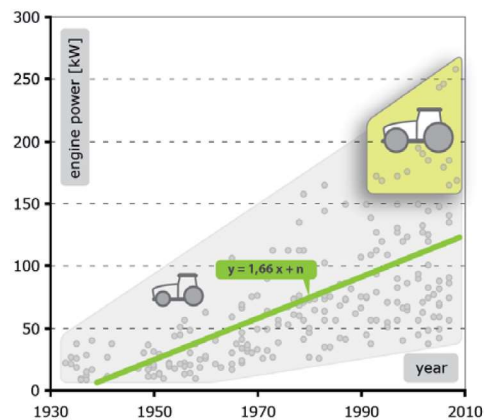

Fonte: Concept Study of a Modular and Scalable Self - Propelled Implement System

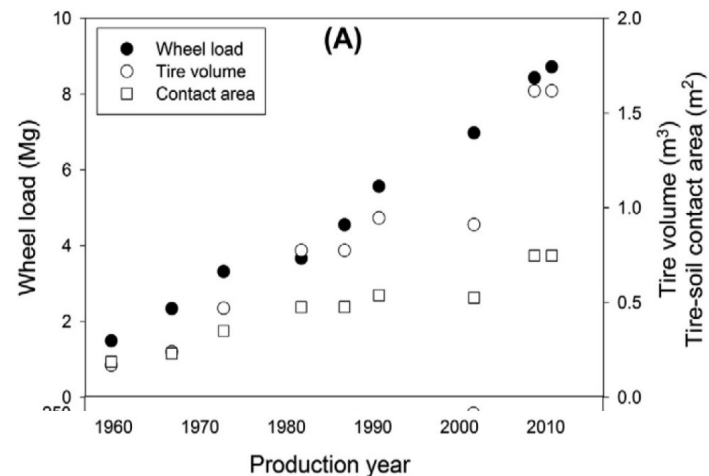

Fonte: Driver-Pressure-State-Impact-Response (DPSIR) Analysis and Risk Assessment for Soil Compaction

Soluzione 1: organi di trazione alternativi alle ruote
Maggiore impronta a terra → limitano compattamento



Soluzione 2: controllo in tempo reale della pressione

Maggiore impronta a terra → limita compattamento

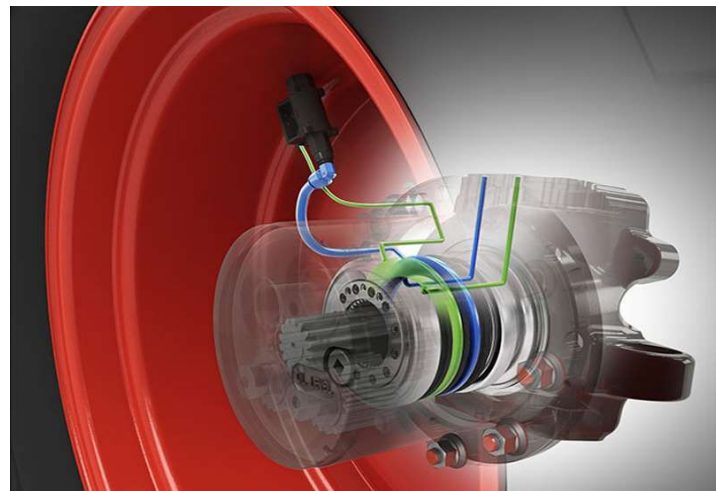
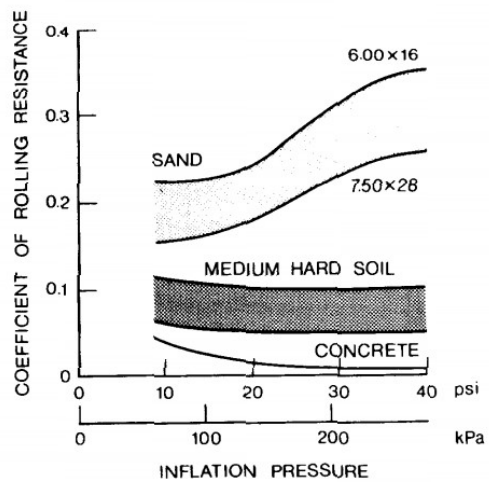



Trattrice o simulatore di volo?



Tecnologie abilitanti per l'agricoltura digitale:

- Telemetria → sensori
- Guida automatica
- ISOBUS Universal Terminal con Task Controller (per le funzionalità evolute)
- Connettività remota
- Attrezzature allo stesso livello

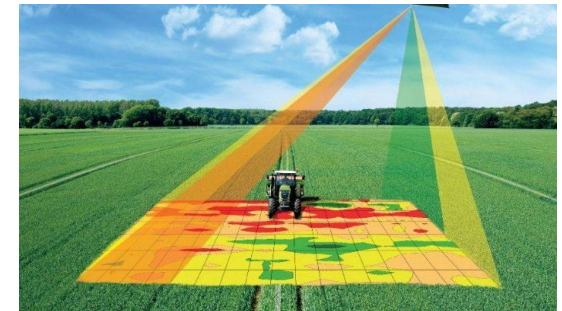

Elettificazione

Oggi → elettificazione attrezzature

La trattore genera potenza elettrica tramite il motore endotermico

La potenza elettrica all'attrezzatura offre nuove possibilità operative



Elettrificazione



Riquadri in **rosso**: non sono, e sicuramente non saranno, disponibili sul nostro mercato

Domani → elettrificazione trazione (??)

Per potenze alte (campo aperto): full electric non praticabile per dimensioni batterie

In corso di sviluppo soluzioni ibride

Altro: idrogeno green?



Parco macchine **irroratrici** in uso in Italia: circa **400'000** unità

35% circa macchine
irroratrici per colture
erbacee



58% circa macchine
irroratrici per colture
arboree



5% circa macchine
portate dall'operatore



Età media: tra 9 e 12 anni

LE PERDITE DI PRODOTTO – Colture arboree

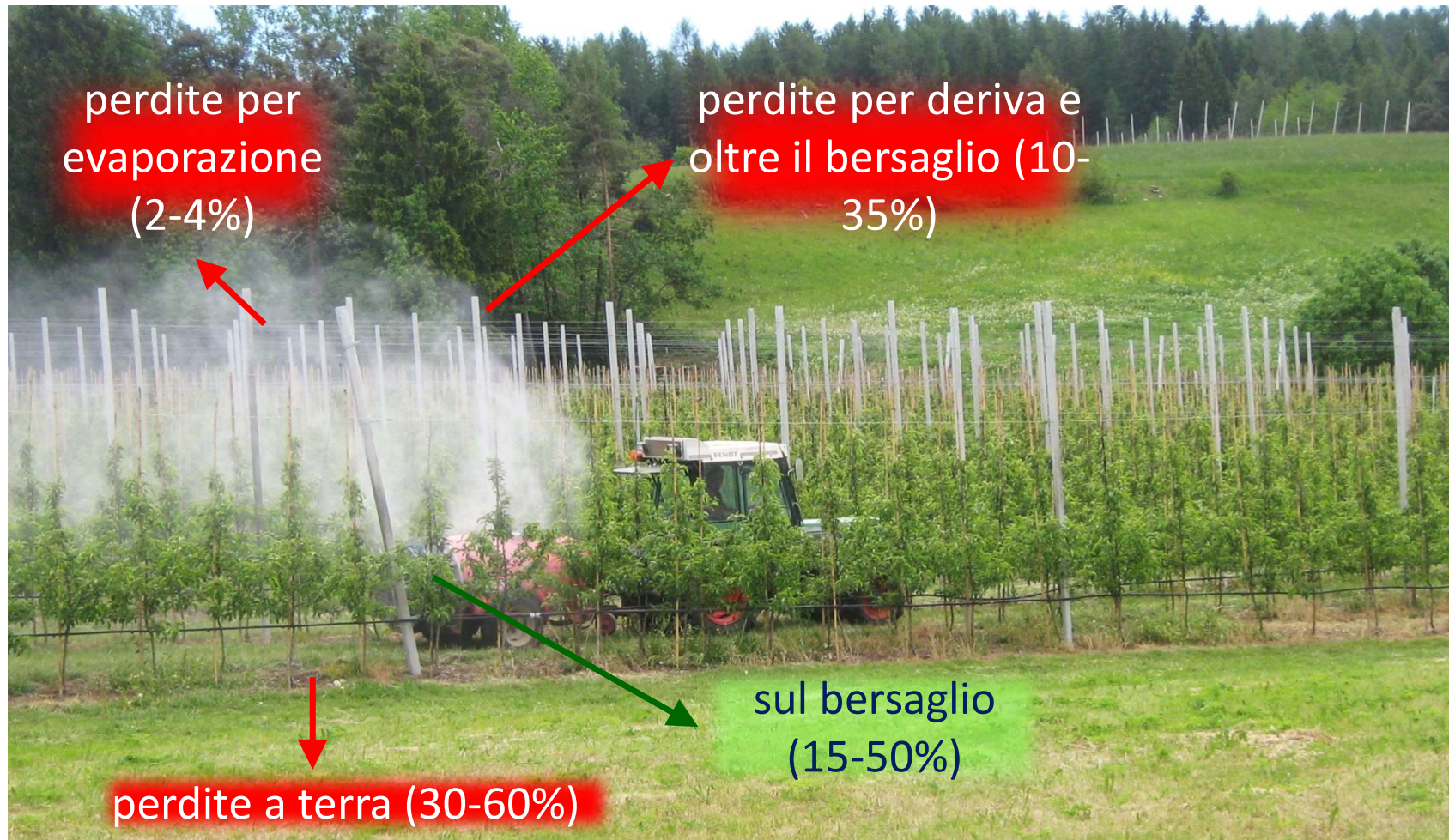

LE PERDITE DI PRODOTTO – Colture erbacee

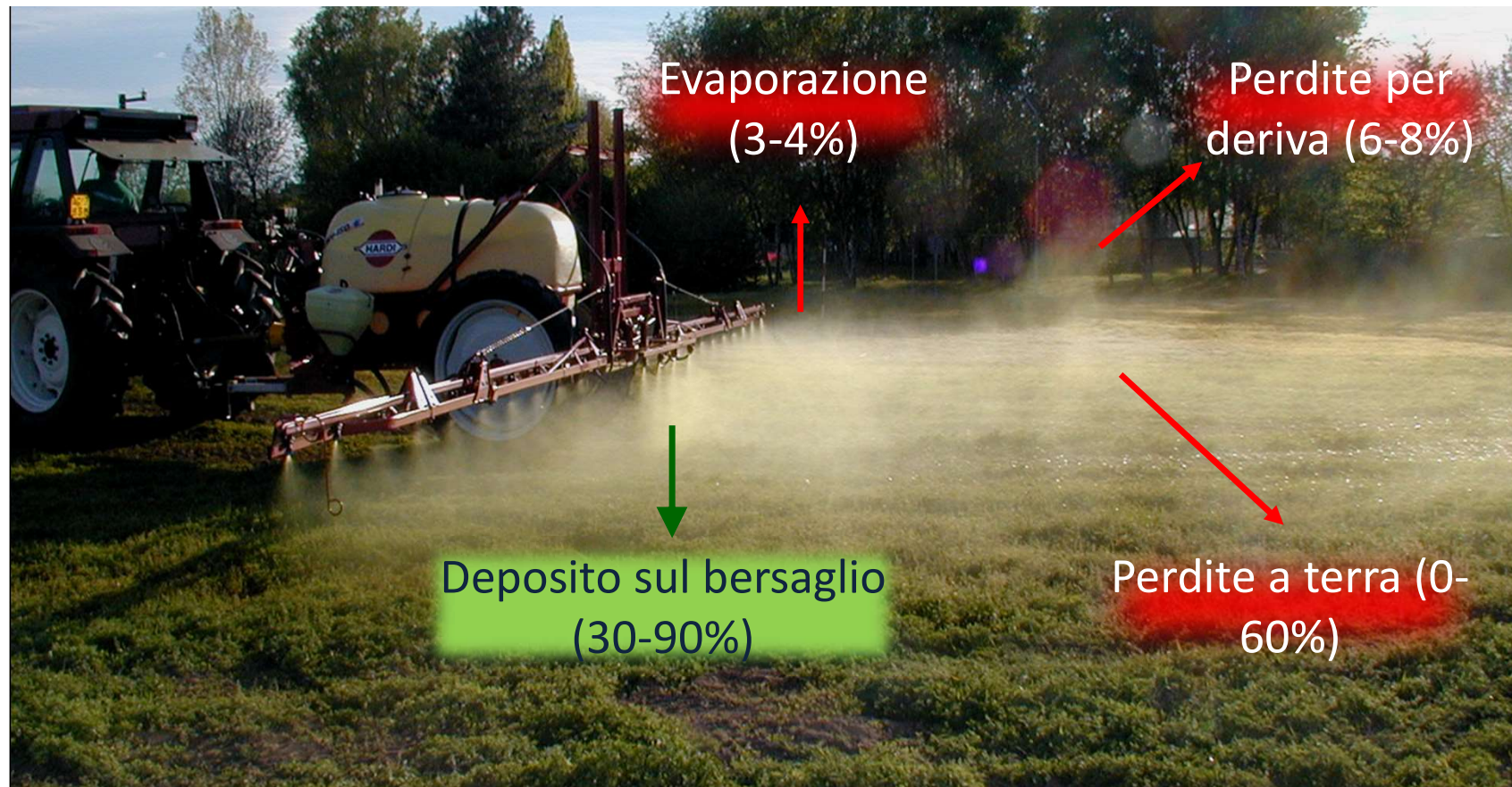

SOLUZIONI BASE - Contaltri automatico con sensori integrati al serbatoio



CONTALTRI ELETTRONICO



SENSORE DI LIVELLO
collegato al contaltri

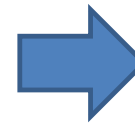

DISPLAY CONTALTRI

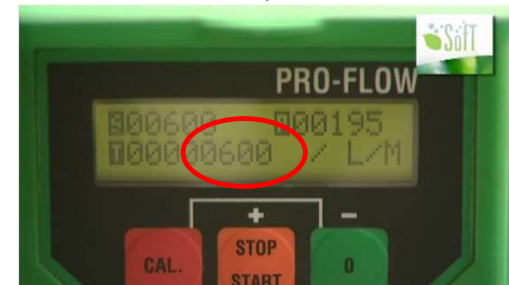
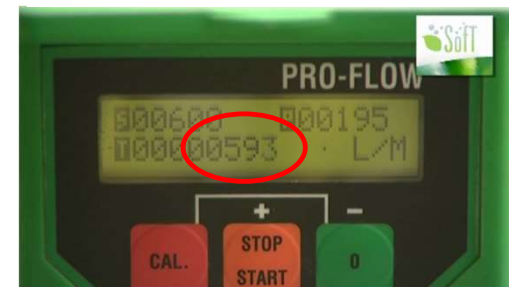

SOLUZIONI BASE –
Cassetta ermetica per
trasporto fitofarmaco





SOLUZIONI BASE - Premiscelatore

con sistema di
introduzione dei prodotti
in polvere

indipendente

montato sull'irroratrice



SOLUZIONI BASE - Dispositivo per il lavaggio dei contenitori vuoti degli agrofarmaci

sul premiscelatore



nell'apertura di
riempimento del
serbatoio dell'irroratrice

indipendente

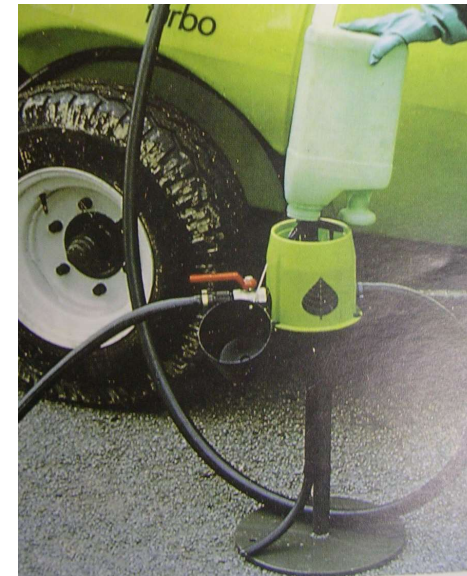

SOLUZIONI BASE – Chiusura aria su ogni lato



aperto



chiuso

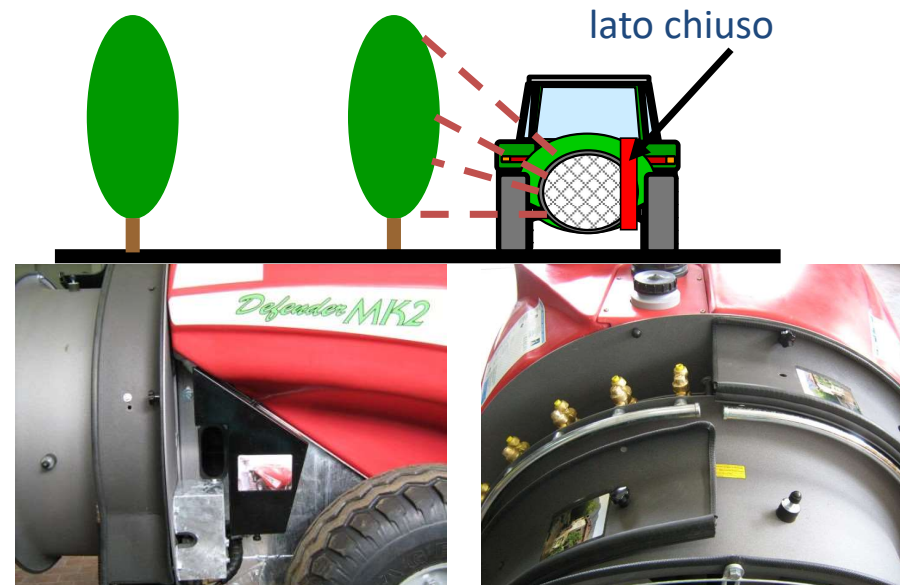

riduzione deriva del 20-50%

SOLUZIONI BASE - Portata proporzionale alla velocità di avanzamento

Sistema che mantiene costante la dose (litri/ettaro) al variare della velocità di avanzamento

Senza tale sistema:

- velocità \uparrow , dose \downarrow -- e viceversa



Sensore di velocità



Regolatore di portata



Sensore di pressione



Sensore di portata



Quadro comandi

SOLUZIONI BASE - Sistemi per la
regolazione della **direzione** del flusso d'aria



SOLUZIONI BASE - Irroratrici scavallanti – con o senza recupero





SOLUZIONI BASE - manica d'aria



VANTAGGI:

- Migliore penetrazione nella vegetazione
- Contenimento della deriva



SOLUZIONI BASE - Ugelli ad iniezione d'aria («antideriva»)



Ugelli
convenzionali

Ugelli a iniezione
d'aria

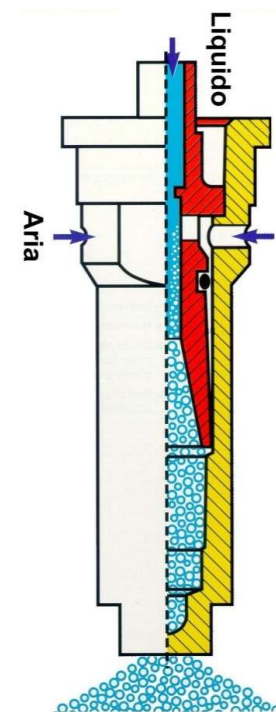

SOLUZIONI BASE – Ritorni calibrati (per macchine prive di controllo elettronico)

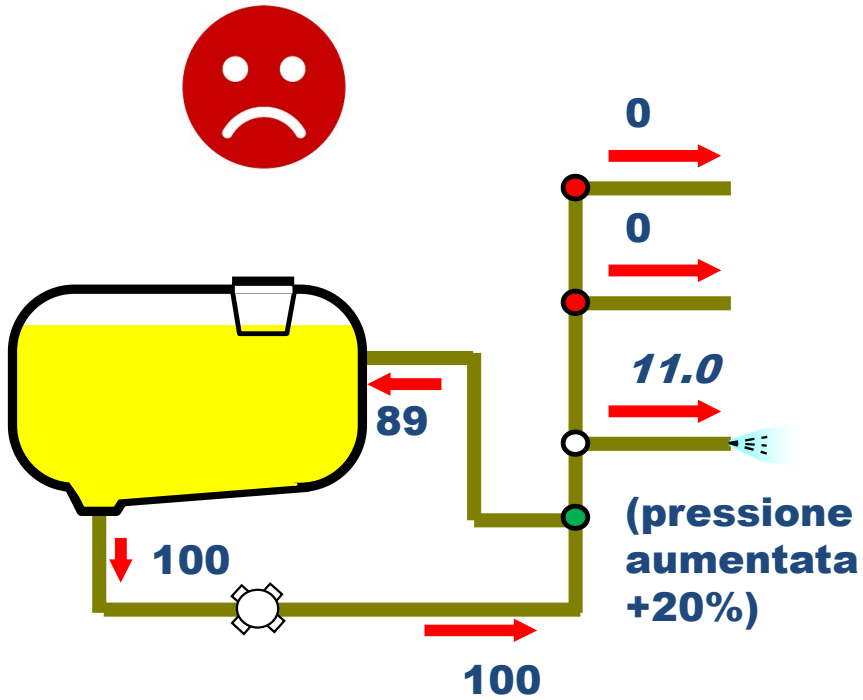

Senza sistema di compensazione

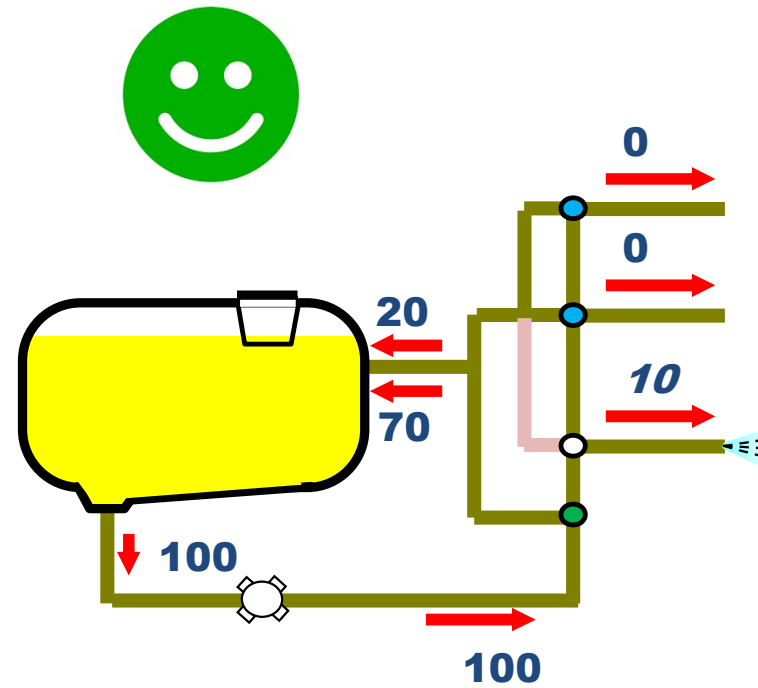

Con sistema di compensazione



SOLUZIONI BASE – Controllo stabilità barra

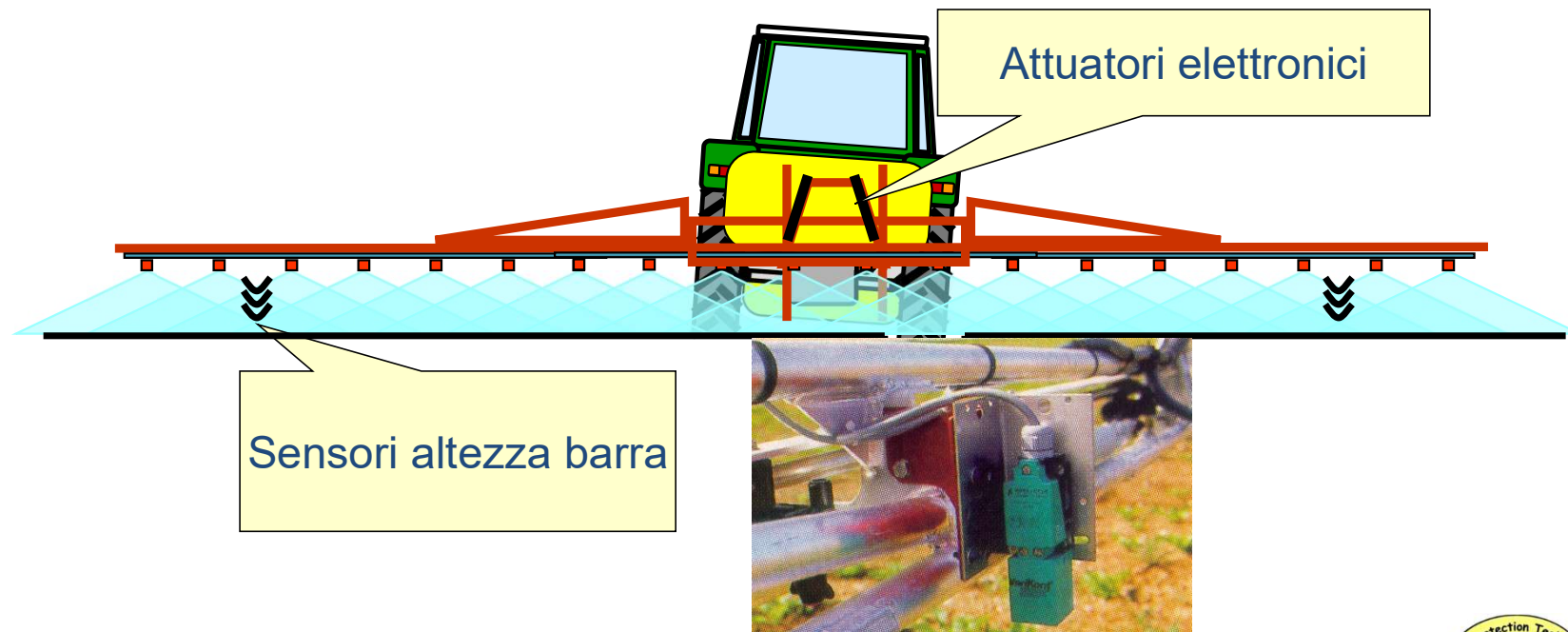

SOLUZIONI BASE – Irroratrici con carica elettrostatica

La miscela
irrorata viene
caricata
negativamente

La pianta ha
carica positiva
(sulla superficie
delle foglie)



Presente solitamente su macchine pneumatiche

Ugelli in numero minore – condizione favorevole
per caricare elettricamente la miscela e
distribuire portate di liquido inferiori (basso
volume)



SOLUZIONI BASE – barre umettanti



Utilizzo limitato al diserbo

Deriva zero

Possibile gocciolamento

Impiegate prevalentemente in risaie (contro riso crodo)

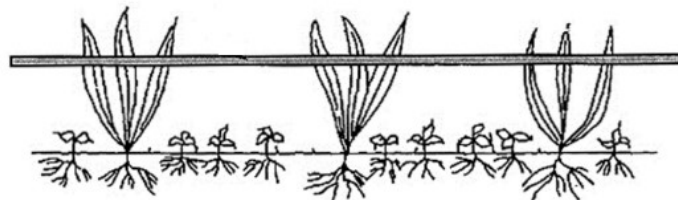

SOLUZIONI BASE – Punto attrezzato di smaltimento in azienda

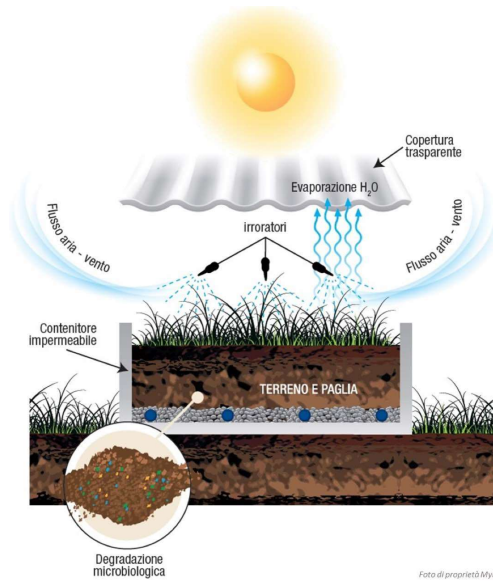

Fondamentale: il 70% dell'inquinamento da fitofarmaci di acque superficiali e profonde viene da fasi di riempimento e lavaggio!!!



SOLUZIONI BASE – Punto attrezzato di smaltimento in azienda



Rifiuti speciali?

Con questa soluzione,
solo *qualche kg* in un
anno!



SOLUZIONI EVOLUTE - Sistema chiuso di introduzione fitofarmaco



SOLUZIONI EVOLUTE – Macchine con irrorazione schermata



SOLUZIONI EVOLUTE – Irroratrice autolivellante per colture in collina

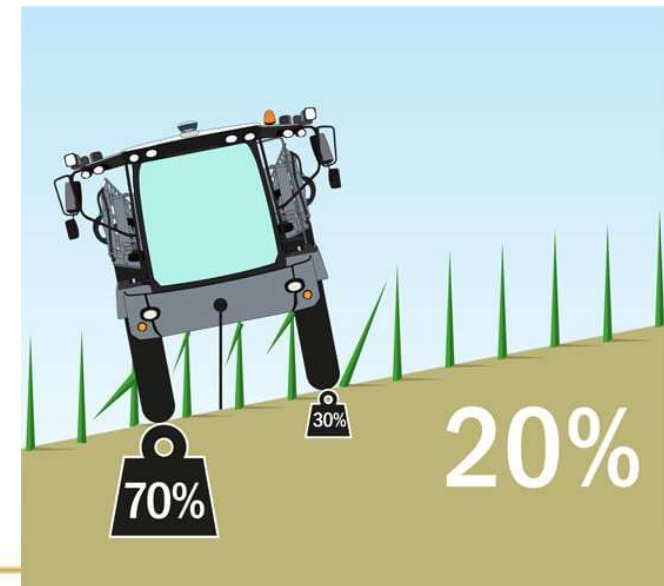
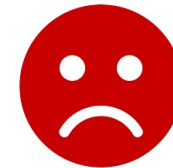

SOLUZIONI EVOLUTE - Sistemi per la regolazione della
portata d'aria

Irroratrice con
ventilatore
azionato da
motore **elettrico**





SOLUZIONI EVOLUTE – Irrorazione «ibrida» elettro-chimica

Viene irrorato un liquido bio-compatibile, che conduce elettricità

La macchina portata posteriormente trasferisce alle infestanti una corrente elettrica

Ha i vantaggi produttivi dell'irrorazione tradizionale, e quelli ambientali della rimozione meccanica



SOLUZIONI EVOLUTE – CDA Controlled Droplet Application

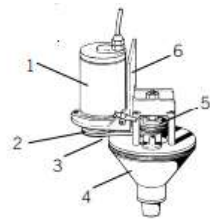

1. Motor
2. Motor Pulley
3. Drive Belt
4. Atomiser Disc
5. Atomiser Pulley
6. Mounting Bracket

Le gocce non sono create dalla pressione, ma dalla veloce rotazione di tre dischi, azionati da un motore elettrico

Obiettivo: ridurre la dose mantenendo lo stesso livello di protezione

Il parametro da controllare è il numero di goccioline (droplet) per unità di superficie di vegetazione



SOLUZIONI EVOLUTE - Pulse width modulation (PWM)

Ugelli non costantemente aperti
Sequenza di aperture – chiusure
Migliora controllabilità puntuale

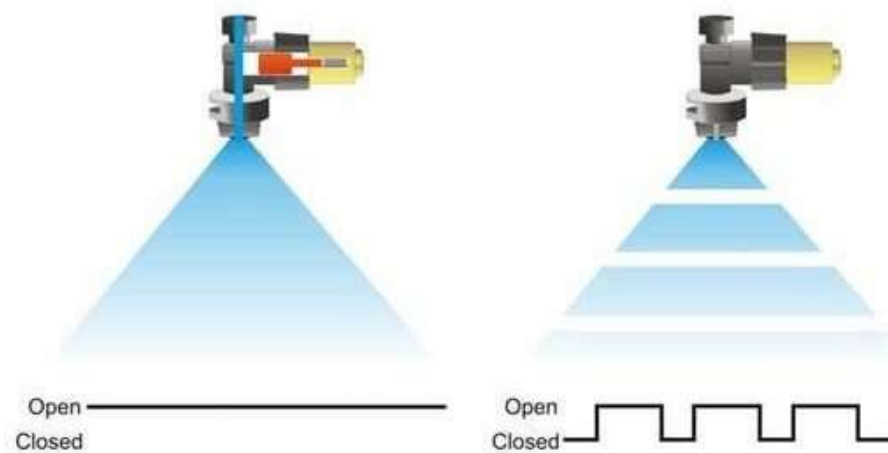

SOLUZIONI EVOLUTE - Pulse width modulation (PWM)

Disponibile anche come retrofit per macchine già in uso

Riduzione dose fino al 40% a parità di efficacia, secondo studi scientifici

(Foliar deposition and coverage on young apple trees with PWM-controlled spray systems)

Ramón Salcedoa, Heping Zhub,*, Zhihong Zhangb, Zhiming Weib, Liming Chenb, Erdal Ozkana, Davide Falchieri

Computers and Electronics in Agriculture 178 (2020) 105794



SOLUZIONI EVOLUTE – Porta-ugelli multipli con controllo automatico

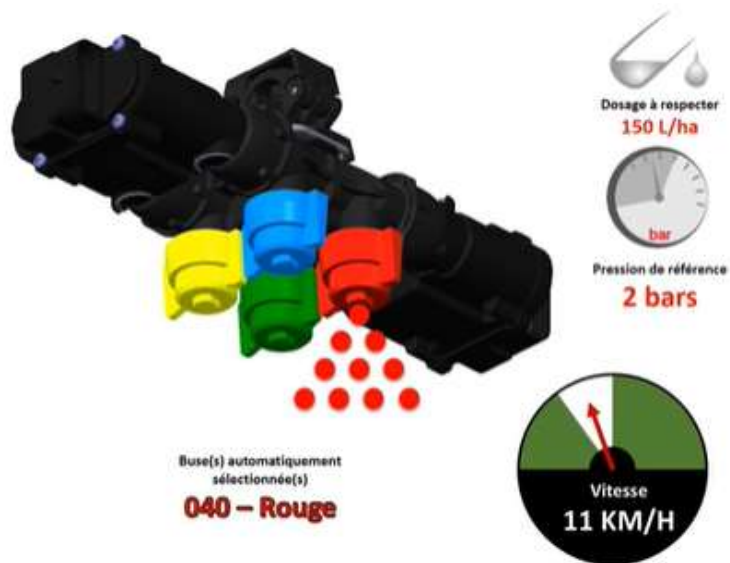



SOLUZIONI EVOLUTE - Trattamento mirato con sensori

Distribuzione convenzionale

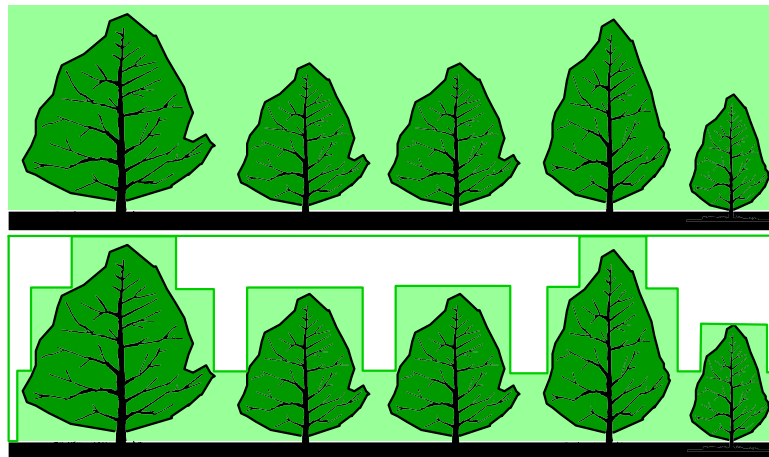

Distribuzione controllata

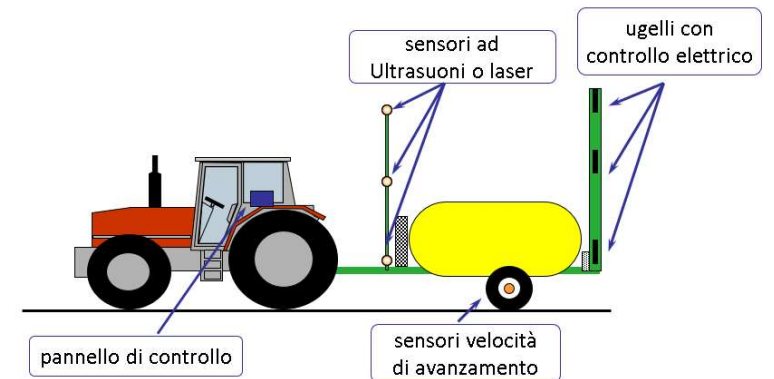
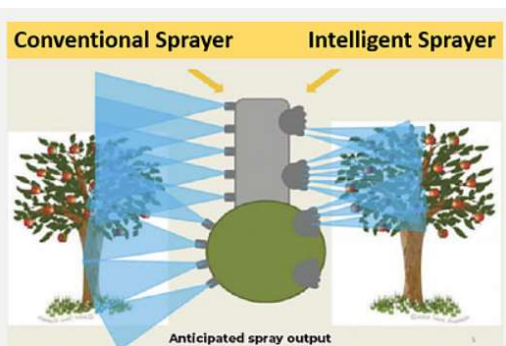



SOLUZIONI EVOLUTE – Controllo delle sezioni di barra e in generale sistemi di ausilio alla guida

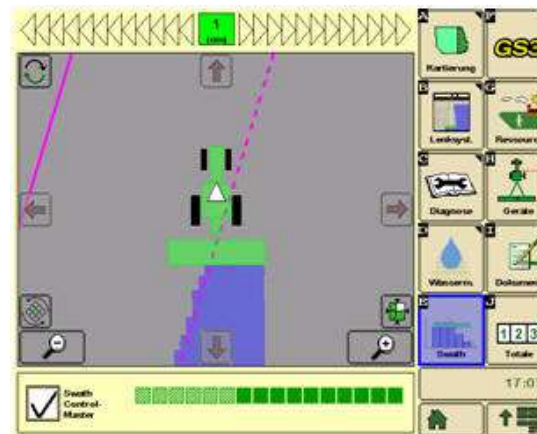
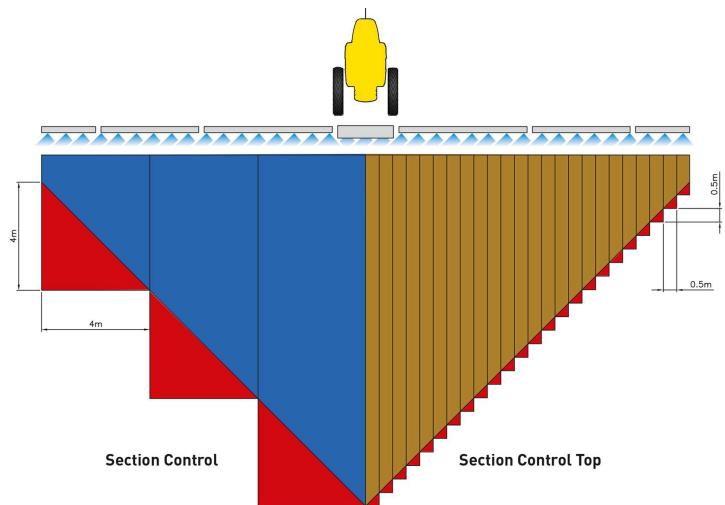

SOLUZIONI EVOLUTE – Irrorazione mirata solo sulle infestanti rilevate

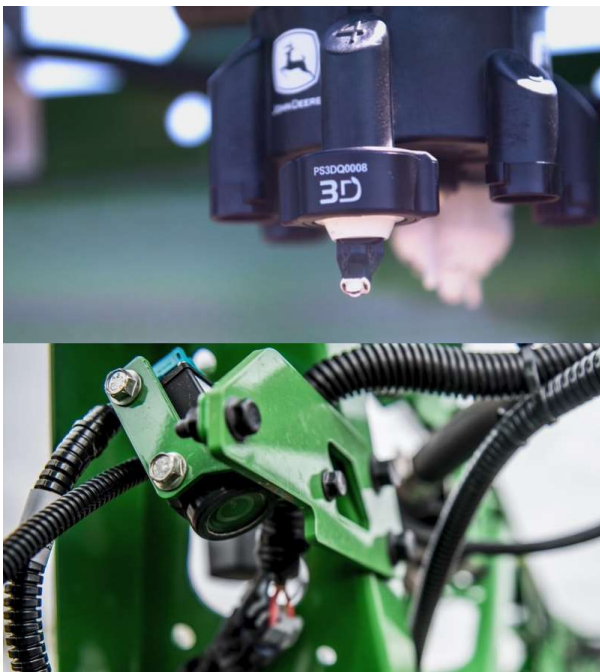

Concetto analogo ad atomizzatore con profilo distribuzione che si adatta a vegetazione

Necessario controllo del singolo ugello

Necessari sensori e centralina con alta capacità di calcolo

SOLUZIONI EVOLUTE – Sensori temperatura e umidità a bordo macchina

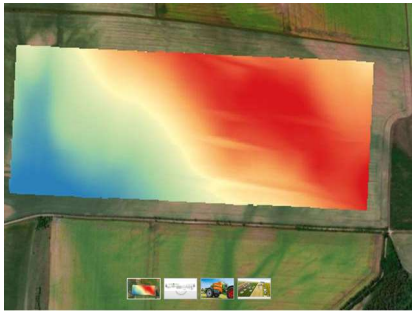

An example of a changing temperature curve for a single area (depending on the time of day, topography, solar radiation, etc.)

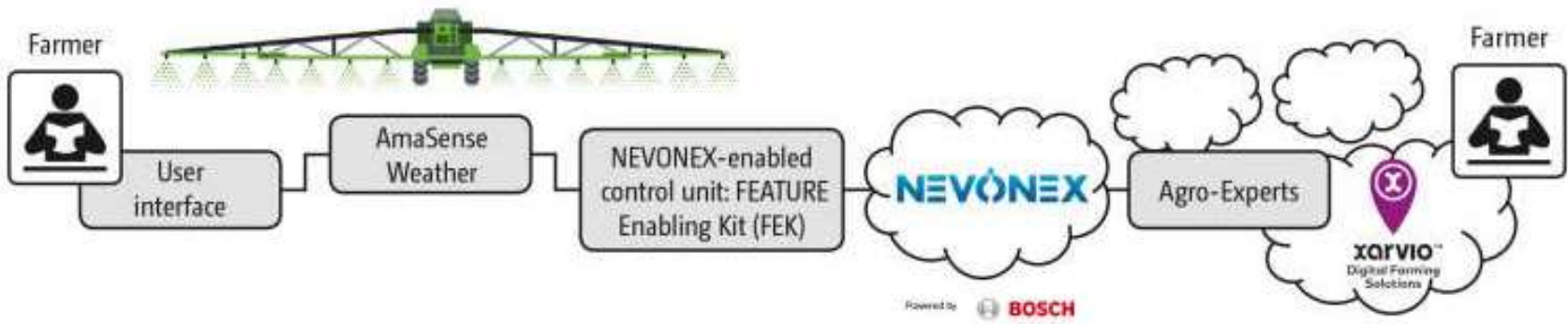



- Elevati costi di funzionamento, manutenzione e riparazione
- Capacità carico e autonomia: ridotte
- Deriva
- Limiti normativi - anche bozza di revisione del PAN ribadisce divieto, con possibili deroghe rilasciate dalle Regioni o dalle Province Autonome, *ma apre alla sperimentazione*

SOLUZIONI EVOLUTE – irrorazione aerea (droni)



- Utilizzabili per monitoraggio
- Distribuzione di imenotteri parassitoidi o batteri sporigeni (lotta biologica o integrata)
- Usi promettenti per mosca dell'olivo
- Diserbo localizzato
- Possibilità di intervento anche con terreno bagnato o in luoghi non praticabili con trattore





SOLUZIONI EVOLUTE – Irroratrici semoventi autonome

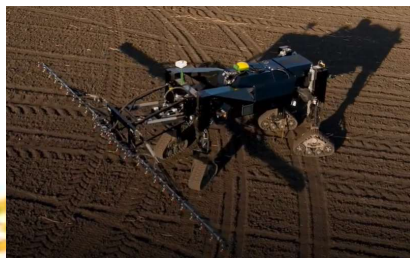



SOLUZIONI EVOLUTE – Iniezione diretta fitofarmaco

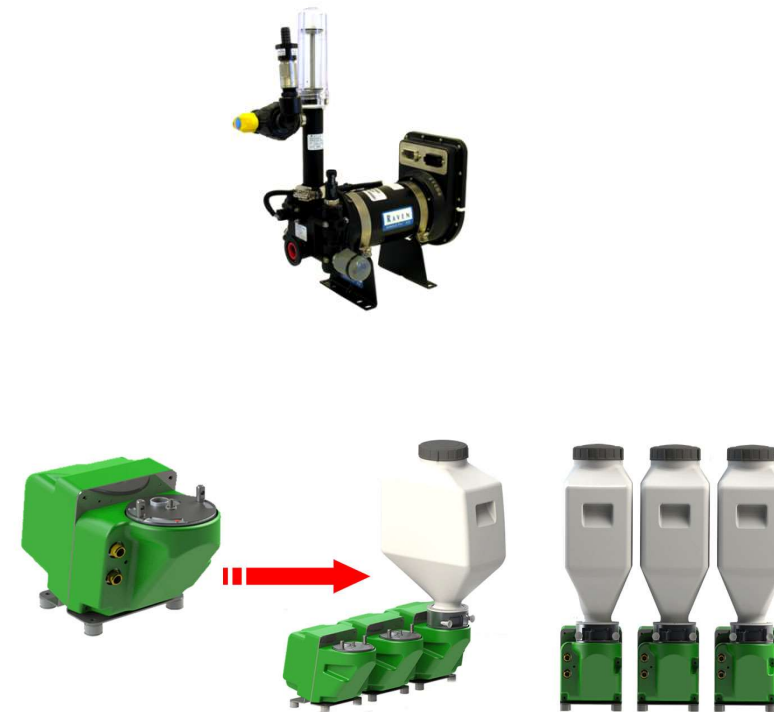
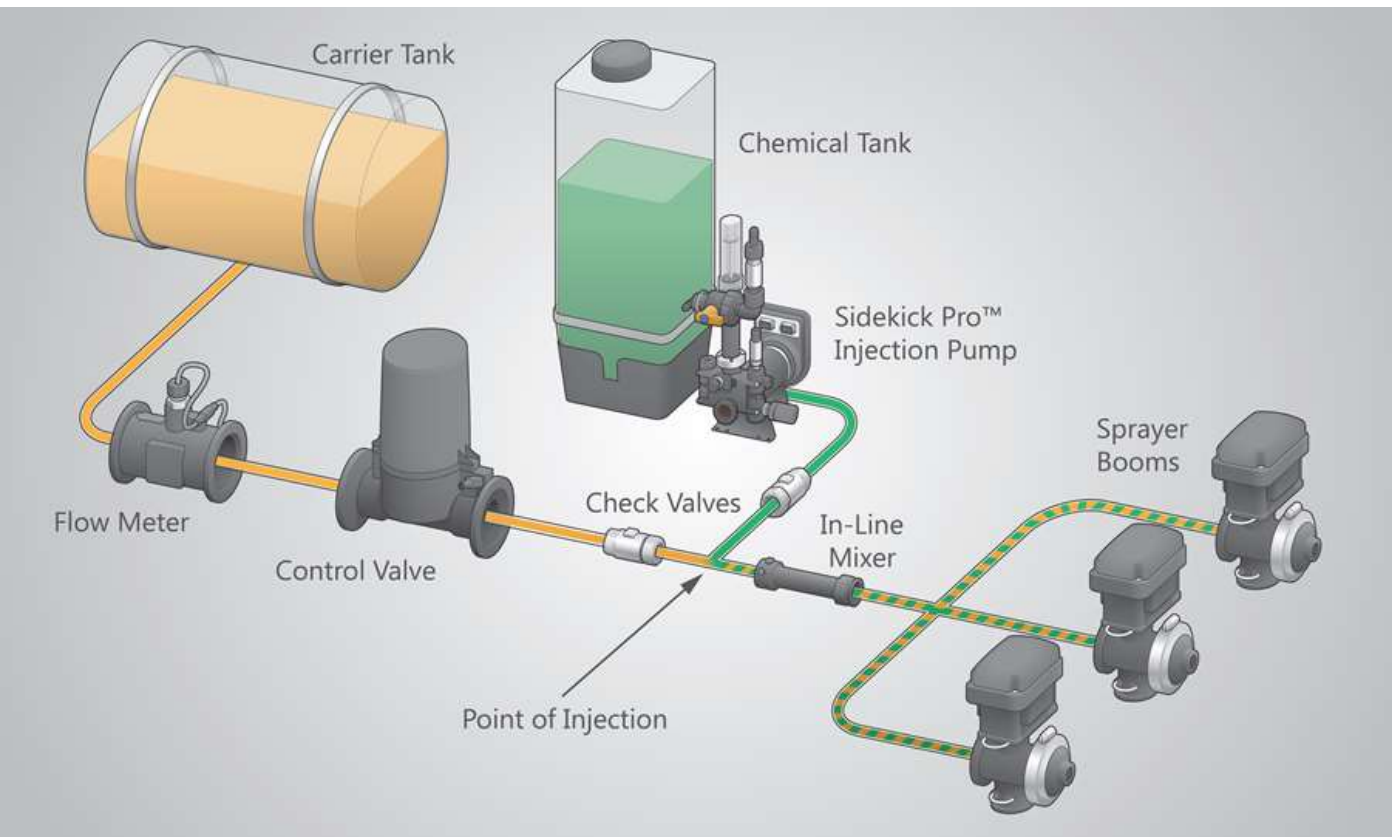

SOLUZIONI EVOLUTE – Svuotamento impianto con aria compressa

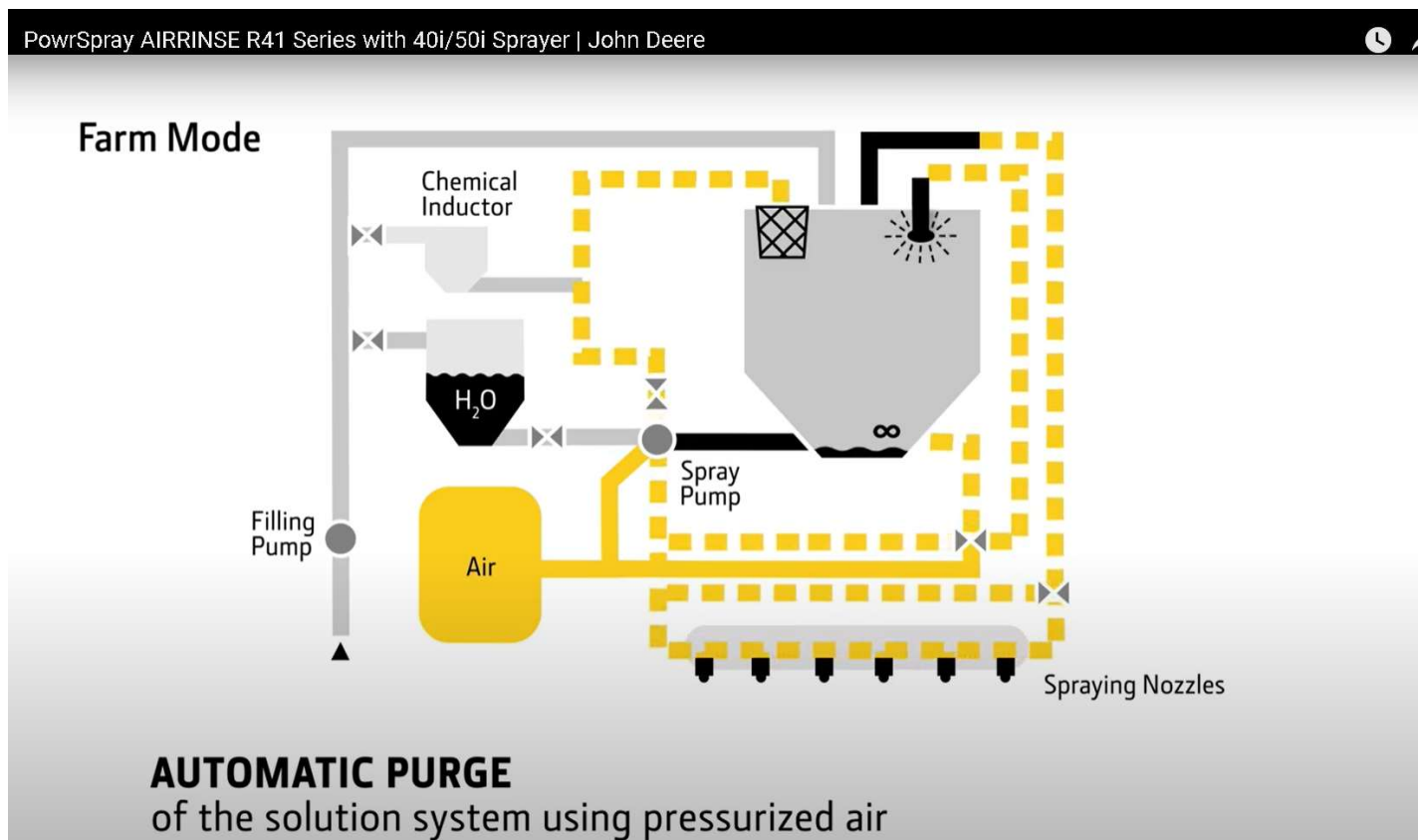

SOLUZIONI EVOLUTE – circuiti separati per riempimento e irrorazione

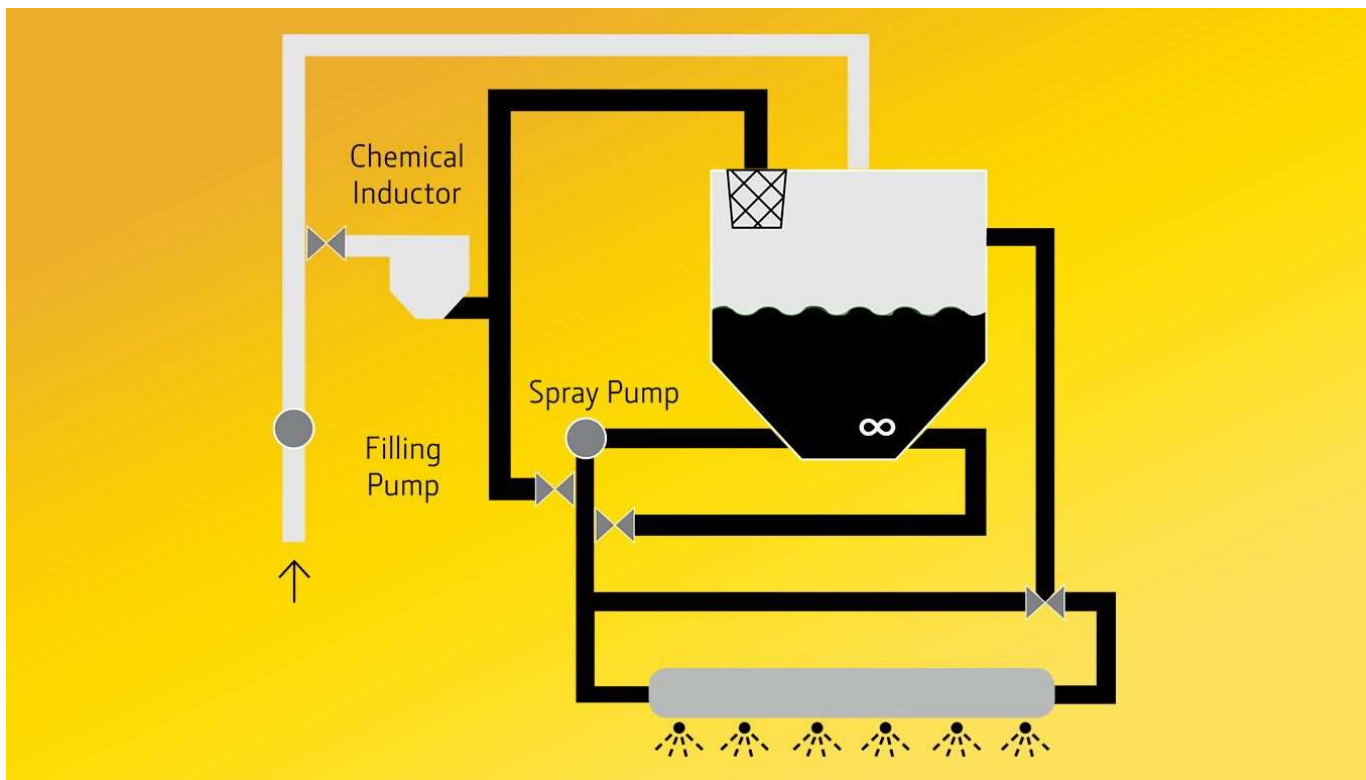



SOLUZIONI EVOLUTE – quaderno di campagna elettronico

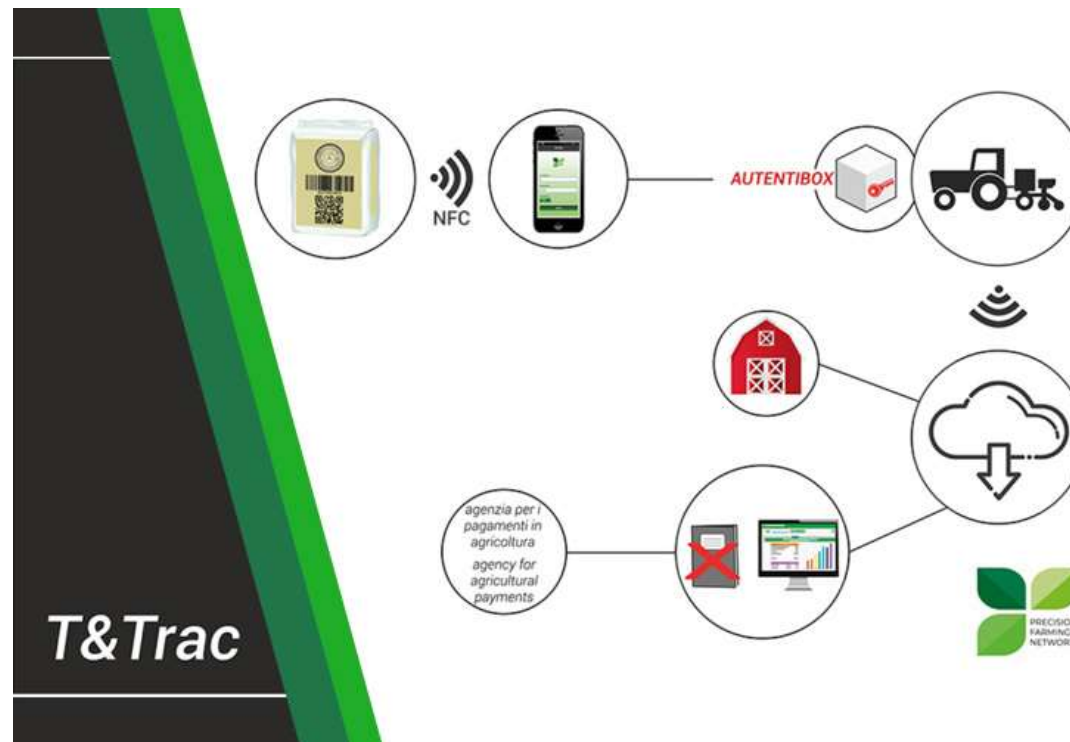

Progetto



Spraying Equipment, Training and **Advising** di tipo **INNO**vativo

Progetto Europeo

Database (anche) di tutte le nuove tecnologie

<https://platform.innoseta.eu/list?type%5B%5D=5>





- Fattori fisici: richiamo
- Rassegna di esempi di macchine
- Progettate specificamente o adatte per lavorazioni in pendenza
- Prodotte da costruttori italiani



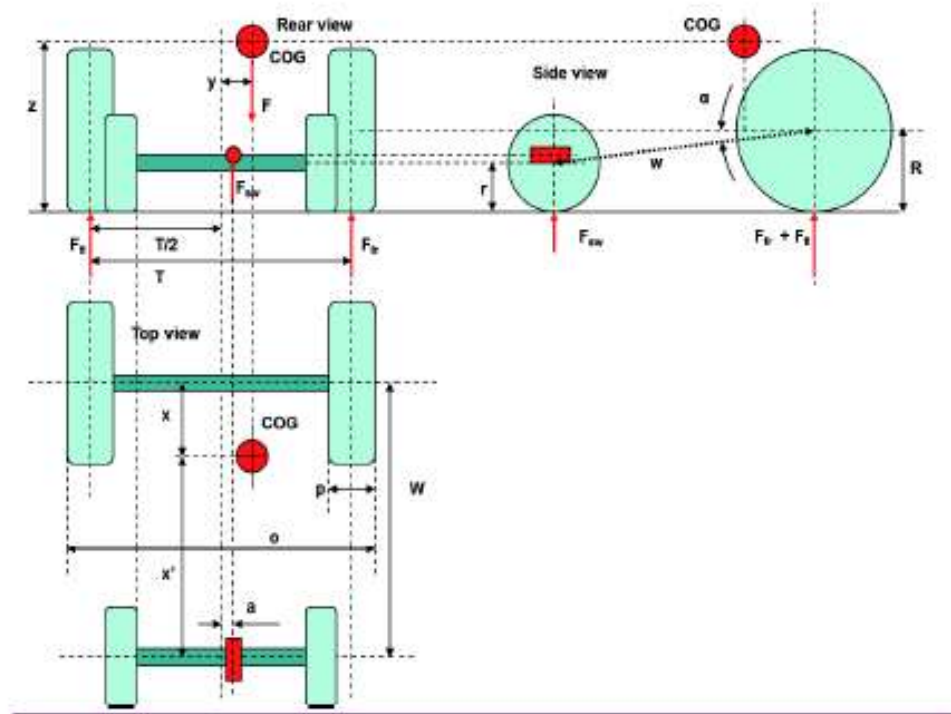

FATTORI FISICI:

- Posizione del baricentro più bassa possibile
- Carreggiata più larga possibile → in frutteto poco margine
- Interazione suolo - organi di trazione





Organi di trazione → spinte laterali



Cingoli o pneumatici dedicati

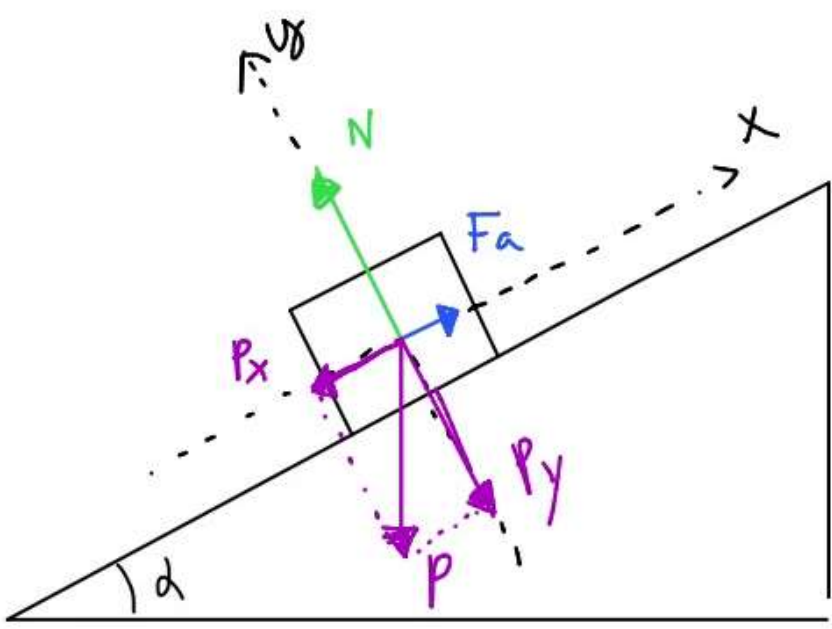

PUNTA DEI TASSELLI ROBUSTA

- STABILITÀ
- RESISTENZA ALL'USURA
- PROPRIETÀ AUTOPULENTI

STABILIZZATORE DEL TALLONE PER UNA STABILITÀ ECCEZIONALE SUI PENDII

CAPACITÀ DI CARICO

PRESSIONE (BAR)	Modelli di punta della concorrenza (kg)	Traxion ES / 70 (kg)
0,8	~1,2	~1,8
1,2	~1,5	~2,2
1,6	~1,8	~2,6
2,0	~2,1	~3,0
2,4	~2,4	~3,4

Al punto della norma ETRTO, rispetto ai modelli di punta della concorrenza a 40 km/h.

VREDESTEIN



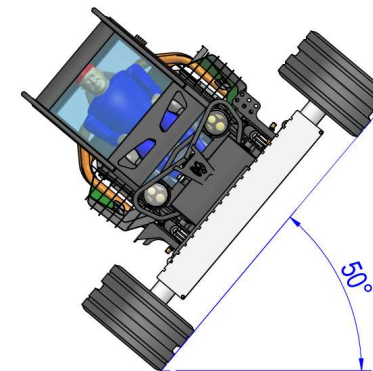
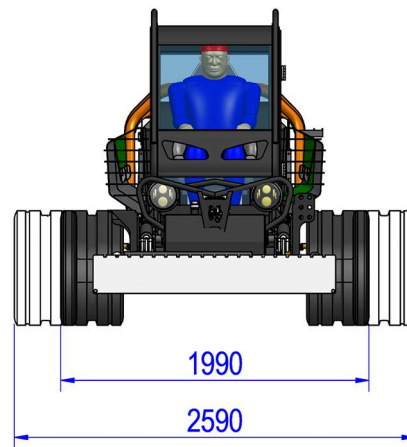
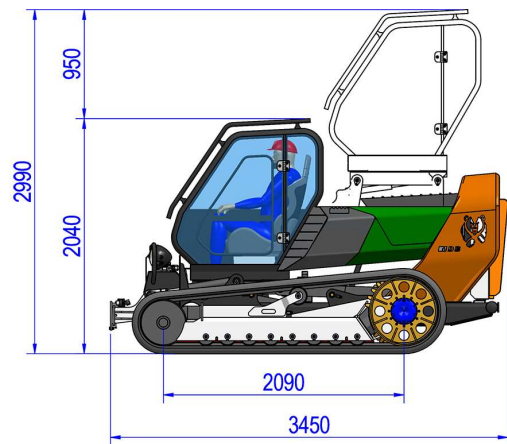



SISTEMI DI LIVELLAMENTO:

- necessari su alcune categorie di macchine
- riportano il baricentro nel poligono di appoggio
- prestazioni per mietitrebbie da montagna: 38% trasversale, 30% longitudinale salita, 14% discesa











Trattrici con pianale di carico - 1





Trattrici con pianale di carico - 2

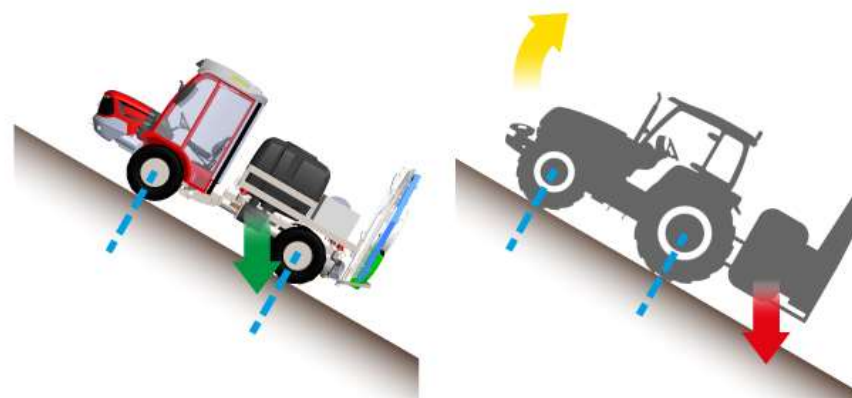



Porta – attrezzi cingolato multifunzione

Applicazioni agri



Seminatrici

1 e 2 – Seminatrici meccaniche per terreni in pendenza

3 – seminatrice meccanica su sodo, compatta





Falciatrici frontali

- Leggerezza
- Compattezza
- Capacità di seguire profilo terreno





Motofalciatrice con
ruote dentate





Barre falcianti





Voltafieno

Ranghinatori





Rotopresse







Rimorchi falcia-autocaricanti



Attrezzatura per la
potatura, portata

Progettata specificamente per
trattrici cingolate



Attrezzatura per la potatura, semovente



Trinciatrici e gruppi interfilari

- Frontali o posteriori
- A spostamento laterale
- Con sensori per aggirare automaticamente i tronchi



Trinciatrici radiocomandate

- Veicoli cingolati anche di alta potenza
- Con possibilità di avere operatore a bordo per trasferimenti
- Specifiche per lavori in pendenza





Lavorazione del terreno

Scavafossi leggero per regimazione acque sui declivi



Fresatrice a spostamento laterale



ALTRI VIDEO

Spandiconcime

- Compatto
- Progettato per lavori in frutteto e vigneto
- Adatto all'uso in pendenza





Sprayers

- Dimensioni compatte
- Baricentro basso
- Alta manovrabilità per inversioni a fine filare



Vendemmiatrice

Dimensioni compatte

Baricentro basso

Con verricello di sicurezza

Progettata specificamente per pendenze estreme (75% longitudinale – 30% vendemmiatrice tradizionale con livellamento)



Macchine raccolta frutta

- Polivalenza: agevolano raccolta, permettono movimentazione cassoni, sono utilizzate per stendere reti antigrandine...
- Sicurezza: il sollevamento di persone impone criteri di progettazione restrittivi



Carrello a forche fuoristrada

- Per movimentazione merci in pendenza

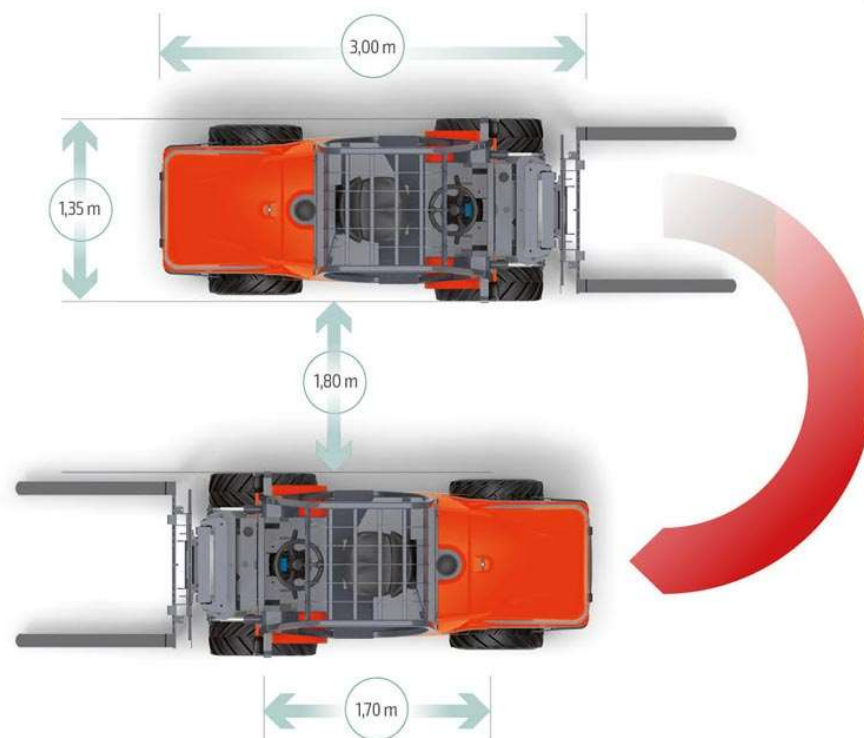



Irrigazione - contesto



- ultimi decenni: **aumento globale temperatura** media superficie pianeta di circa 0.9 °C nel decennio 2006-2016 rispetto alla media di riferimento del 1850-1900
 - maggiore **intensità locale precipitazioni**, con riduzione di intensità efficace per la ricarica degli acquiferi
 - allungamento locale dei **periodi secchi**
 - criticità in continua evoluzione per **riduzione precipitazioni nevose** e concentrazione piogge in periodi brevi
 - **Penalizzata la ricarica delle falde** in quota
 - **minore portata** dei bacini verso valle
 - Impiego non razionale dei **fertilizzanti** → aumento temperature (indiretto) e peggioramento qualità dei corpi idrici
 - Per contro, **incremento di uso d'acqua nell'agricoltura**
-

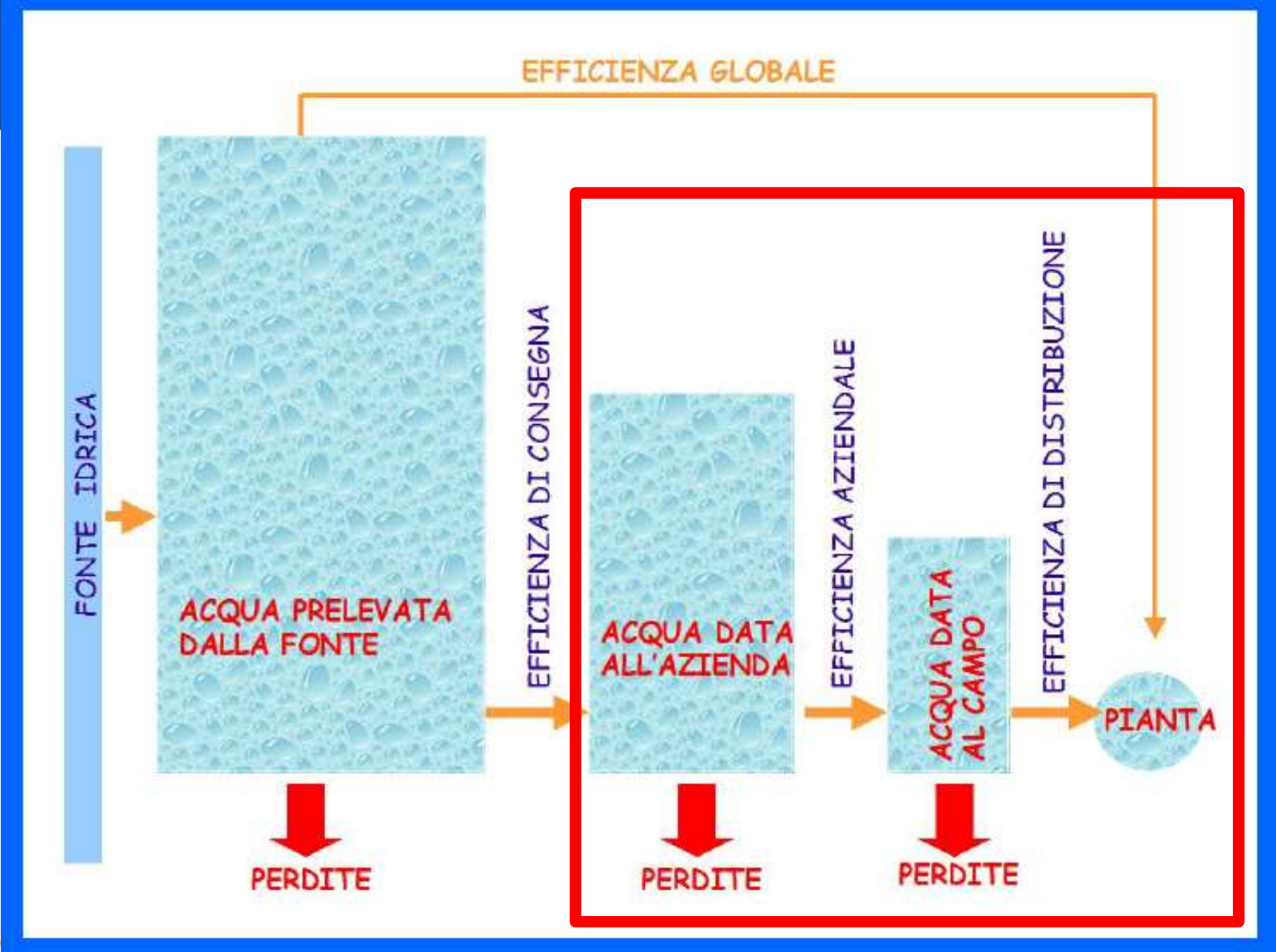



EFFICIENZA --

sommersione (risaie)	25-30%
• scorrimento superficiale	40-50%
• aspersione tradizionale	70-75%
• Aspersione macchine moderne	80-85%
• microirrigazione (goccia, spruzzo)	80-90%
• Microirrigazione interrata e ULDI	90-95%

... ma ...

Nessuna scelta di sistemi irrigui efficienti ha effetto se l'irrigazione viene effettuata:

- **Se non ce ne è bisogno** (perdita completa acqua e danno per la coltura)
- **Nel momento sbagliato** (inefficienza acqua e carenza od eccesso per la pianta)
- **Con un volume scorretto** (inefficienza e perdita acqua per evaporazione o percolazione profonda)

UNA BUONA GESTIONE DELL'IRRIGAZIONE PORTA AD EFFICIENZA MOLTO SUPERIORI A QUELLE DELLA SEMPLICE SCELTA DEL SISTEMA IRRIGUO

Sensore BioRistor su pomodoro

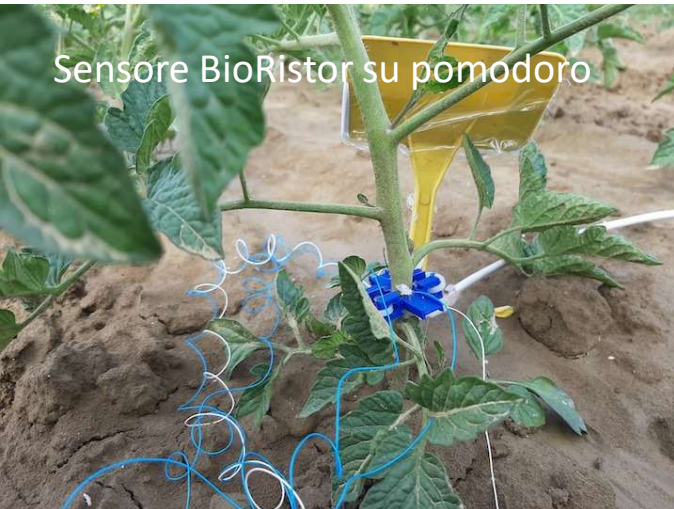

Monitoraggio – Decisione – Attuazione

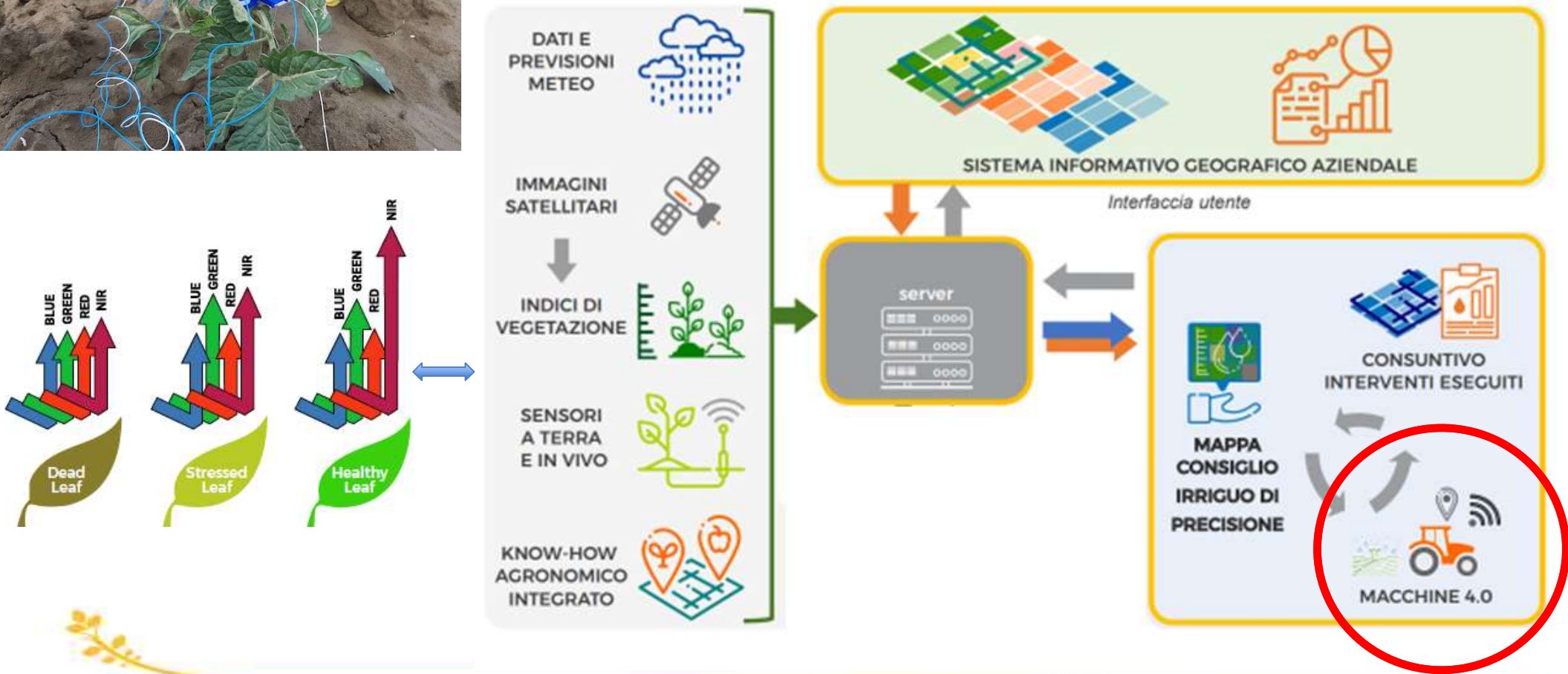

Irrigazione - aspersione

- Sistemi per aumento efficienza di distribuzione
- Sistemi per ridurre sforzo riavvolgimento condotta (rotoloni)
- Elektrificazione riavvolgimento
- Sistemi di controllo da remoto
- Regolazione pluviometria
- Riduzione perdite per evaporazione (ali piovane anzichè irrigatore a getto per i rotoloni, *sistemi LEPA* con calate per pivot e rainger*)

*LEPA=Low Energy Precision Application



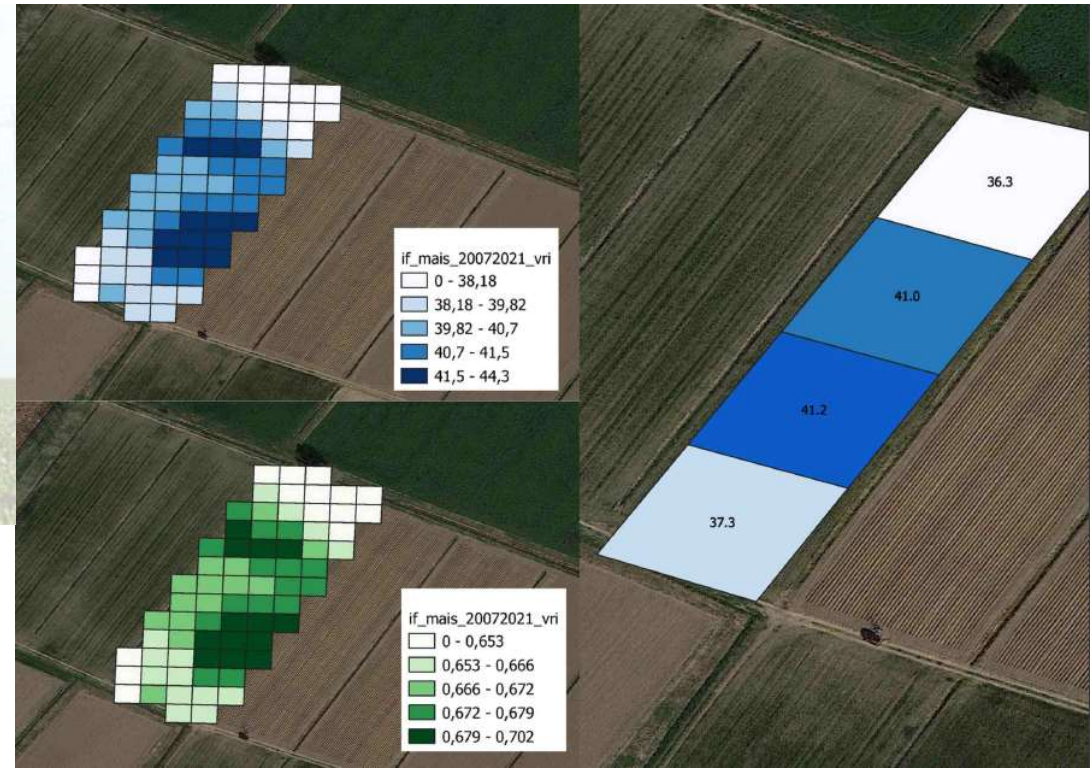

Rateo variabile: controllo velocità avanzamento, controllo sezioni, controllo singolo ugello

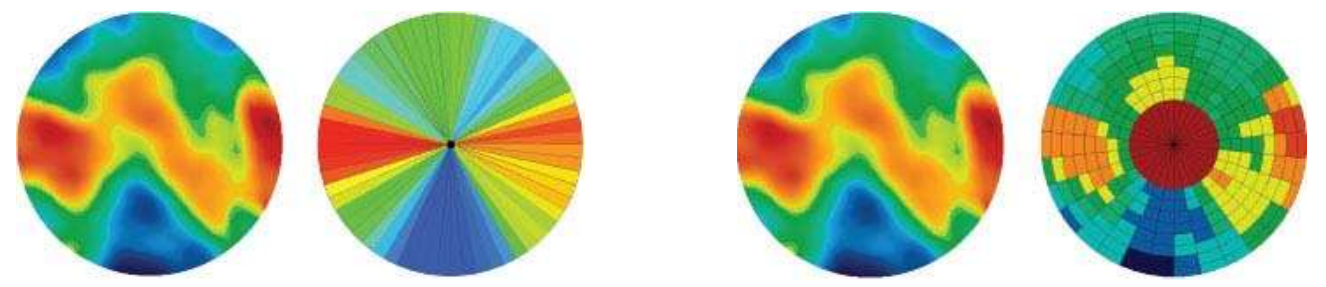
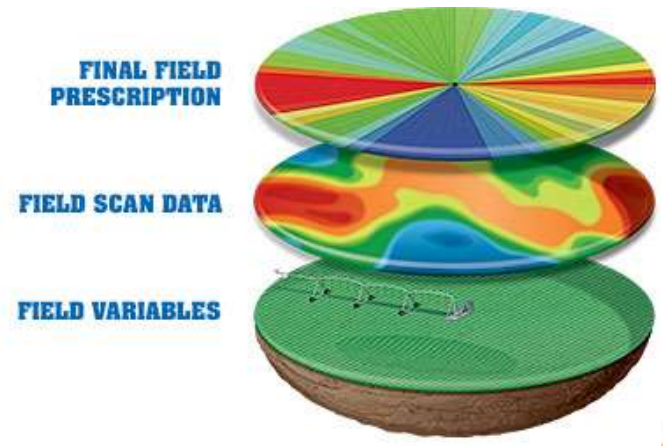

Irrigazione - goccia

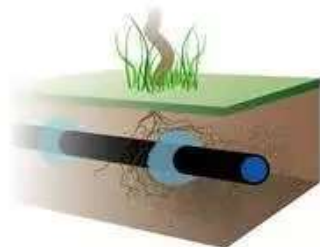



Stress idrico controllato (Regulated deficit irrigation)

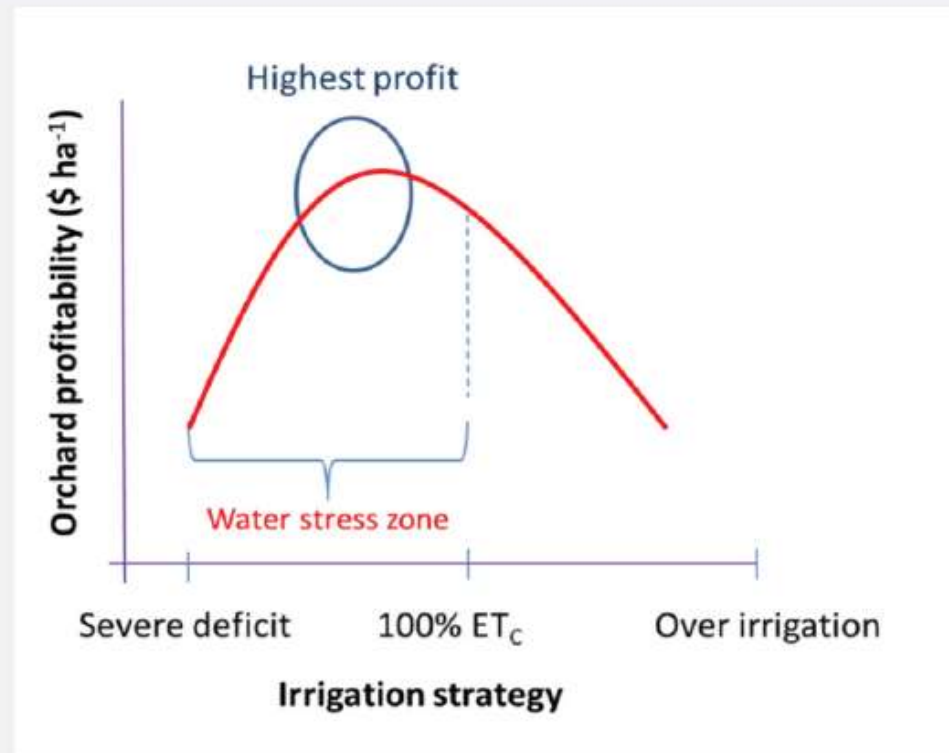

Figure 1: Theoretical relationship between orchard profitability and irrigation strategy (Deficit: <100% ET_c; 100% ET_c; and Over irrigation: >100% ET_c) for fruit crops subjected to regulated deficit irrigation.



- Razionalizzare uso risorsa idrica
- Ottimizzare fattore lavoro (h/uomo)
- Ridurre consumo energetico impianto
- Integrare altri fattori produzione (fertilizzazione)



- Ultra Low Volume (fino a 0,35 l/h)
- Filtrazione (sistemi a dischi)
- Fertirrigazione
- Micro-irrigazione con tecnica aspersione (frutteto)
- Antibrina

- Sistemi 4.0: controllo da remoto, verifica parametri, sensori e centraline per consiglio irriguo e aggiustamento real-time
- Elettificazione pompe (→ automazione)
- Autocompensazione gocciolatori (→ tracciabilità portate)
- Gestione separata per settori (da progettare in base a mappe o esigenze colturali)



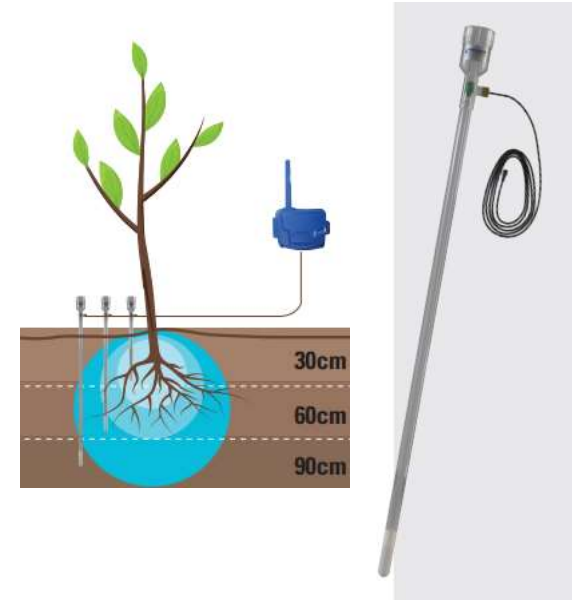
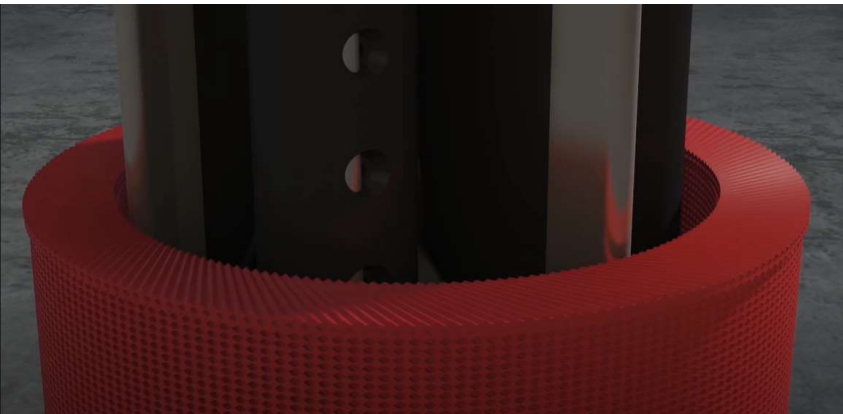





I punti fondamentali

TRATTRICI: innovazione in tutti gli aspetti, dal motore endotermico, alla trasmissione, fino alla generazione di potenza elettrica e alle tecnologie digitali

IRRORATRICI: determinanti per riduzione dell'impatto ambientale – vedere <https://platform.innojeta.eu/list?type%5B%5D=5&s=>

MACCHINE PER LAVORAZIONI IN PENDENZA: full line disponibile – fattori comuni: dimensioni compatte e baricentro basso

MACCHINE PER IRRIGAZIONE: ridurre e ottimizzare. Controllo (sensori) e comunicazione (dati)





Remind: compilazione questionario a fine giornata



Davide Gnesini

Responsabile Servizio Tecnico FederUnacoma

Tel. +39 0516333957 – Fax +39 0516333896

E-mail: davide.gnesini@federunacoma.it

Website: www.federunacoma.it

